

**DEPARTMENT OF  
MECHANICAL ENGINEERING  
5<sup>TH</sup> SEMESTER**

**LECTURE NOTES**

**ON**

Refrigeration and Air Conditioning

## **Introduction to Refrigeration:**

For specific applications, efficiencies of both living and non-living beings depend to a great extent on the physical environment. The nature keeps conditions in the physical environment in the dynamic state ranging from one extreme to the other. Temperature, humidity, pressure and air motion are some of the important environment variables that at any location keep changing throughout the year. Adaptation to these many a times unpredictable variations is not possible and thus working efficiently is not feasible either for the living beings or the non- living ones. Thus for any specific purpose, control of the environment is essential. Refrigeration and air-conditioning is the subject which deals with the techniques to control the environments of the living and non-living subjects and thus provide them comforts to enable them to perform better and have longer lives.

### **Refrigeration**

Literal meaning of refrigeration is the production of cold confinement relative to its surroundings. In this, temperature of the space under consideration is maintained at a temperature lower than the surrounding atmosphere. To achieve this, the mechanical device extracts heat from the space that has to be maintained at a lower temperature and rejects it to the surrounding atmosphere that is at a relatively higher temperature. Since the volume of the space which has to be maintained at a lower temperature is always much lower than the environment, the space under consideration experiences relatively higher change in temperature than the environment where it is rejected.

The precise meaning of the refrigeration is thus the following: Refrigeration is a process of removal of heat from a space where it is unwanted and transferring the same to the surrounding environment where it makes little or no difference. To understand the above definition, let us consider two examples from the daily life.

It is a well-known fact that the spoilage of food and many other items reduces at a lower temperature. At a lower temperature, molecular motion slows down and the growth of bacteria that causes food spoilage also retards. Thus to preserve many types of perishable food products for a longer duration, we use refrigerators (Figure 1.1) in our homes, canteens, hotels, etc. The temperature of the food products has to be maintained at a level below that of surroundings. For this we keep the food products in a refrigerator. The inside volume of the refrigerator where we store food products or any other items is much less than the volume of the room where the refrigerator is kept. The room in this case is the surrounding environment. Food products in the refrigerator initially were at a higher temperature than desired temperature, meaning that it had some unwanted heat. If its heat is removed, its temperature will decrease. The refrigerator removes unwanted heat from the food products and throws away that heat to the room – the surrounding environment of the refrigerator. The amount of heat makes a big difference in temperature inside the refrigerator and almost little or no difference in the temperature of the room.

As a second example let us consider travel in a car in an Indian summer of Delhi or Kanpur. Outside temperature is very high. It is highly uncomfortable. For a comfortable drive, now-a-days we have air-conditioned cars. You will come to know later, that refrigeration is an integral component of air-conditioning. To have a comfortable drive in the car, the temperature inside the car has to be lowered from about  $40^{\circ}\text{C}$  to  $25^{\circ}\text{C}$ . This means that heat of the space inside of the car and its occupants has to be thrown outside. This is done by the refrigeration unit fitted in the car. The volume of the car is much less than that of the surroundings. With the rejected heat there is an appreciable change in the temperature inside the car, but no change in the temperature of the surroundings.

In many places and situations, environment temperature is lower than the temperature of the space that we desire. As an example consider car driving in the Winter of Delhi or Kanpur.

Temperature outside is about  $2-6^{\circ}\text{C}$ . For a comfortable drive with light clothing, temperature inside the car has to be about  $25^{\circ}\text{C}$ . This means that heat has to be supplied or pumped inside the car and thus its temperature has to be increased. The machinery that performs this operation is known as heat pump. But in applications such as that of the comfortable driving in a car that depending upon the season requires temperature to be lower or higher than the surroundings, heat has to be pumped to the car or rejected from the car.

Since both the operations are performed by the same unit in the car, in a much broader sense we can say that a refrigeration unit controls the temperature of a space. In the normal refrigeration system, this is done by reversing the operation.

In refrigeration, heat is pumped out from a lower temperature space to a higher temperature environment. We know from our experience in daily life that water flows from a higher level to a lower level and heat flows from a body at a higher temperature to a body at a lower temperature. The reverse, i.e., flow of water from a lower level to a higher level and flow of heat from a body at a lower temperature to a body at a higher temperature do not occur naturally. In practice these are achieved at the cost of external work (power) done on the water and the carrier of heat (here the refrigerant) with help of a mechanical device.

Whether the space under consideration has to be maintained at a temperature lower or higher than the surrounding environment, to pump out or in the heat, external power is always required. In relation to heat pump, this will be explained later.

### **Air Conditioning**

Merely lowering or raising the temperature does not provide comfort in general to the machines or its components and living beings in particular. In case of the machine components, along with temperature, humidity (moisture content in the air) also has to be controlled and for the comfort of human beings along with these two important parameters, air motion and cleanliness

also play a vital role. Air conditioning, therefore, is a broader aspect which looks into the simultaneous control all mechanical parameters which are essential for the comfort of human beings or animals or for the proper performance of some industrial or scientific process. The precise meaning of air conditioning can be given as the process of simultaneous control of temperature, humidity, cleanliness and air motion. In some applications, even the control of air pressure falls under the purview of air conditioning. It is to be noted that refrigeration that is control of temperature is the most important aspect of air conditioning.

To understand the above definition in a better way, let us consider one example. In the summer, the temperature in Delhi is about 10 °C higher than in Kolkata where temperature varies in the range of 32 °C to 35 °C. We feel uncomfortable in both places. Weather in Delhi is hot and dry (moisture content in the air is low) whereas in Kolkata it is (mild) hot but humid (moisture content in the air is very high). If we go to a hill-station, say Shillong in the summer, we feel comfortable there.

Temperature there remains about 25 °C and relative humidity of the air is also in the comfortable range, say about 65%. In Delhi, temperature is very high and humidity is low, whereas in Kolkata, temperature is low but humidity is high. In Delhi if there is a rain, we feel more comfortable whereas in Kolkata even with rain, the relative comfort is less. In Delhi temperature falls down and humidity also increases towards the comfortable value. In Kolkata, temperature falls down but humidity still remains on the higher side. Thus, for comfort, both temperature and humidity have to be in the specified range. This is true for both human beings and scientific processes. Apart from the above two, from intuition one can also say that purity or cleanliness of the air is an essential item for the comfort and it has been established that the air motion is also required for the comfort condition.

Depending upon the requirement, air conditioning is divided into the summer air conditioning and the winter air conditioning. In the summer air conditioning, apart from cooling the space, in most of the cases, extra moisture from the space is removed, whereas in the winter air conditioning, space is heated and since in the cold places, normally the humidity remains low, moisture is added to the space to be conditioned. The summer air conditioning thus uses a refrigeration system and a dehumidifier. The winter air conditioning uses a heat pump (refrigeration system operated in the reverse direction) and a humidifier. Depending upon the comfort of the human beings and the control of environment for the industrial products and processes, air conditioning can also be classified as comfort air conditioning and industrial air conditioning. Comfort air conditioning deals with the air conditioning of residential buildings, offices spaces, cars, buses, trains, airplanes, etc. Industrial air conditioning includes air conditioning of the printing plants, textile plants, photographic products, computer rooms, etc.

It has been mentioned above that the refrigeration and air conditioning are related. Even when a space has to be heated, it can be done so by changing the direction of flow of the refrigerant in the refrigeration system, i.e., the refrigeration system can be used as a heat pump (how this is possible will be explained later). However, some section of the people, treat refrigeration exclusively the process that deals with the cooling of the space. They treat heating operation associated with the heat pump.

## BRIEF HISTORY OF REFRIGERATION

In the past around 4000 years from now, people in India and Egypt are known to produce ice by keeping water in the porous pots outside the home during the night period. The evaporation of water in almost cool dry air and radiative heat transfer between the water and the deep sky that is at a very low temperature (much below the freezing point of ice) caused the formation of ice even though the surrounding air was at a higher temperature than the freezing point of water. There are a few accounts in China about the use of ice around 1000 BC for cooling the beverages. In 4<sup>th</sup> century A.D., East Indians were producing ice by dissolving salt in water.

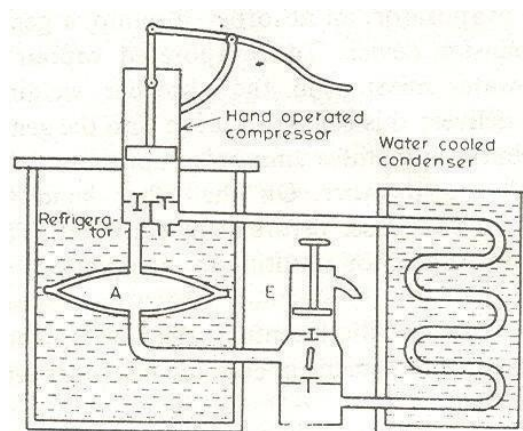

### Schematic of the Hand-Operated Refrigeration Machine of Jacob Perkins

Because of the very small amount of production, the aforesaid methods were not feasible for commercial applications. Natural ice is limited to certain regions, therefore, the absence of good quality insulation systems in those days forced the man to develop methods to produce ice artificially. Out of many pioneers' work on refrigeration side, a few are presented here. In 1790 the first British Patent was obtained by Thomas Hariss and John Long. In 1834 Jacob Perkins developed a hand operated refrigeration system using ether as the working fluid (Figure 1.5). Ether vapor was sucked by the hand operated compressor and then high temperature and pressure ether vapor was condensed in the water cooled chamber that served as the condenser. Liquid ether was finally throttled to the lower pressure, which was then evaporated in a

chamber called evaporator, A. With the evaporation, temperature of the water surrounding the evaporator fell down and finally the ice was formed. In this system, either was used again and again in the cyclic process with negligible wastage.

The first American patent of a cold air machine to produce ice in order to cure people suffering from high fever was obtained by Dr. John Gorrie of Florida in 1851. In 1860, instead of air or ether, Dr. James Harrison of Australia used sulfuric ether. This was the world's first installation of refrigeration machine for brewery. In 1861, Dr. Alexander Kirk of England constructed a cold air machine similar to that of Dr. Gorrie. In his machine, air was compressed by a reciprocating compressor driven by a steam engine running on coal.

In the 19<sup>th</sup> century, there was remarkable development of refrigeration systems to replace natural ice by artificial ice producing machines. In the beginning of the 20<sup>th</sup> century, large sized refrigeration machines were developed. In 1904 in the New York Stock Exchange, about 450 ton cooling machine was installed. In Germany, people used air conditioning in theater. Around 1911 the compressors with speed between 100 to 300 rpm were developed. In 1915, the first two-stage modern compressor was developed.

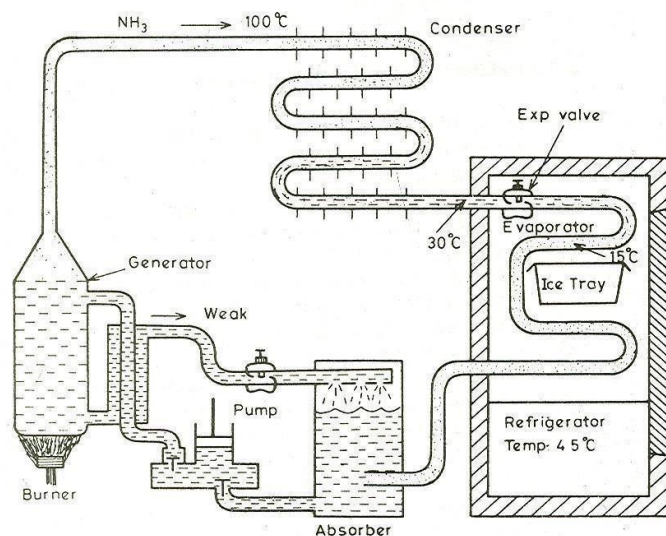

**Vapor-Absorption Machine of Ferdinand Carre**



To meet the demand for ice during the civil war, Ferdinand Carre of the USA developed a vapor-absorption refrigeration system (Figure 1.6) using ammonia and water. Carre's system consisted of an evaporator, an absorber, a pump, a generator, a condenser and an expansion device. The evaporated vapor is absorbed by the weak ammonia-water mixture in the absorber yielding strong aqua ammonia. The pump delivers this strong solution into generator where heat transfer from a burner separates ammonia vapor and the weak ammonia returns to the absorber. On the other hand the ammonia vapor condenses in the condenser before being throttled. The throttled liquid ammonia enters the evaporator resulting in completion of the cyclic process.

Until about 1920s the development in refrigeration system was restricted to the refinement in the cold-air machines and vapor-compression systems. After 1920s, there has been extensive diversification in the growth of refrigeration systems leading to new developments such as vortex tube, thermoelectric, pulse-tube, steam-jet, centrifugal compression systems, etc. The most important development can be the invention of new refrigerants which were chlorfluor hydrocarbons. This development occurred in 1930 in GE Corporation of USA at a time when Refrigeration industry had begun to stagnate on the use of  $\text{NH}_3$   $\text{SO}_2$  as refrigerant. The chlorfluor carbons offered the advantages of best refrigerants and were proven non-toxic substances in comparison with  $\text{NH}_3$  and  $\text{SO}_2$ . Other developments took place due to special requirements to utilize waste heat or low grade energy or materials of specific properties for thermoelectric effect. Owing to the likelihood of energy crisis in the future, many commercial units have been developed that utilizes waste heat or solar energy.

### **Applications of Refrigeration and Air Conditioning**

The fields of refrigeration and air conditioning are although interconnected, as shown in Figure 1.4, each has its own province too. The largest application of refrigeration is for air

conditioning. In addition, refrigeration embraces industrial refrigeration including the processing and preservation of food, removing heat from substances in chemical, petroleum and petrochemical plants, and numerous special applications such as those in the manufacturing and construction industries.

In a similar manner, air conditioning embraces more than cooling. The comfort air conditioning is the process of treating air to control simultaneously its temperature humidity, cleanliness, and distribution to meet the comfort requirements of the occupants of the conditioned space. Air conditioning, therefore, includes entire heating operation as well as regulation of velocity, thermal radiation, and quality of air, including removal of foreign particles and vapors.

Some applications of refrigeration and air conditioning are as follows :

#### **Air Conditioning of Residential and Official Buildings**

Most of the air conditioning units are devoted for comfort air conditioning that is meant to provide comfortable conditions for people. Air conditioning of building is required in all climates. In the summer, living/working spaces have to be cooled and in the winter the same have to be heated. Even in places where temperature remains normal, cooling of the building is required to remove the heat generated internally by people, lights, mechanical and electrical equipment. Further in these buildings, for the comfort, humidity and cleanliness of air has to be maintained. In hospitals and other medical buildings, conditions on cleanliness and humidity are more stringent. There ventilation requirements often specify the use of 100 percent outdoor air, and humidity limits.

#### **Industrial Air Conditioning**

The term industrial air conditioning refers to providing at least a partial measure of comfort for workers in hostile environments and controlling air conditions so that they are favorable to

processing some objects or materials. Some examples of industrial air conditioning are the following:

### **Spot Heating**

In a cold weather it may be more practical to warm a confined zone where a worker is located. One such approach is through the use of an infrared heater. When its surfaces are heated to a high temperature by means of a burner or by electricity, they radiate heat to the affected area. If a specific area has to be cooled, it will be unwise to cool entire room or factory. In this case, conditions may be kept tolerable for workers by directing a stream of cool air onto occupied areas.

### **Environmental Laboratories**

The role of air conditioning may vary from one laboratory to the other. In one laboratory, a very low temperature, say  $-40^{\circ}\text{C}$  must be maintained to test certain equipment at low temperatures, and in another, a high temperature and humidity may be required to study behavior of animals in tropical climates.

### **Printing**

In printing industries, control of humidity is a must. In some printing processes the paper is run through several different passes, and air conditioning must be maintained to provide proper registration. If the humidity is not properly maintained the problems of static electricity, curling or buckling of paper or the failure of the ink to dry arise.

### **Textiles**

Like paper, textiles are sensitive to changes in humidity and to a lesser extent changes in temperature. In modern textile plants, yarn moves at very high speeds and any changes in

flexibility and strength of the yarn because of the change in humidity and temperature will thus affect the production.

### **Precision Parts and Clean Rooms**

In manufacturing of precision metal parts air conditioning helps to (a) keep the temperature uniform so that the metal will not expand and contract, (b) maintain a humidity so that rust is prevented and (c) filter the air to minimize dust.

### **Photographic Products**

Raw photographic materials deteriorate fast in high humidity and temperatures. Other materials used in coating film also require a careful control of temperature. Therefore, photographic- products industry is a large user of refrigeration and air conditioning.

### **Computer Rooms**

In computer rooms, air conditioning controls temperature, humidity and cleanliness of the air. Some electronic components operate in a faulty manner if they become too hot. One means of preventing such localized high temperature is to maintain the air temperature in the computer room in the range of 20 to 23 °C. The electronic components in the computer functions favorably at even lower temperatures, but this temperature is a compromise with the lowest comfortable temperature for occupants. A relative humidity of about 65% is maintained for comfort condition.

### **Air Conditioning of Vehicles**

For comfortable journey, planes, trains, ships, buses are air conditioned. In many of these vehicles the major contributor to the cooling load is the heat from solar radiation and in case of public transportation, heat from people.

## **Food Storage and Distribution**

Many meats, fish, fruits and vegetables are perishable and their storage life can be extended by refrigeration. Fruits, many vegetables and processed meat, such as sausages, are stored at temperatures just slightly above freezing to prolong their life. Other meats, fish, vegetables and fruits are frozen for many months at low temperatures until they are defrosted and cooked by consumer.

## **UNIT OF REFRIGERATION AND COP**

The standard unit of refrigeration is *ton refrigeration* or simply *ton* denoted by TR. It is equivalent to the rate of heat transfer needed to produce 1 ton (2000 lbs) of ice at 32 °F from water at 32 °F in one day, i.e., 24 hours. The enthalpy of solidification of water from and at 32 °F in British thermal unit is 144 Btu/lb.

## **VAPOUR COMPRESSION CYCLE**

Vapour compression cycle is an improved type of air refrigeration cycle in which a suitable working substance, termed as refrigerant, is used. The refrigerants generally used for this purpose are ammonia (NH<sub>3</sub>), carbon dioxide (CO<sub>2</sub>) and sulphur-dioxide (SO<sub>2</sub>).

The refrigerant used, does not leave the system, but is circulated throughout the system alternately condensing and evaporating. In evaporating, the refrigerant absorbs its latent heat from the solution which is used for circulating it around the cold chamber and in condensing; it gives out its latent heat to the circulating water of the cooler. The vapour compression cycle which is used in vapour compression refrigeration system is now-a-days used for all purpose refrigeration. It is used for all industrial purposes from a small domestic refrigerator to a big air conditioning plant.

## Simple Vapour Compression Refrigeration System:

It consists of the following essential parts:

### Compressor

The low pressure and temperature vapour refrigerant from evaporator is drawn into the compressor through the inlet or suction valve A, where it is compressed to a high pressure and temperature. This high pressure and temperature vapour refrigerant is discharged into the condenser through the delivery or discharge valve B.

### Condenser

The condenser or cooler consists of coils of pipe in which the high pressure and temperature vapour refrigerant is cooled and condensed.

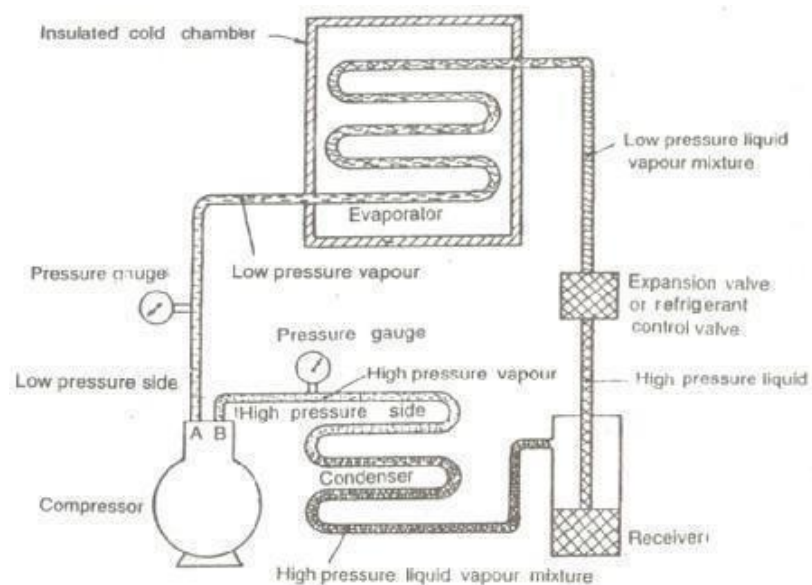

## Simple Vapour Compression Refrigeration System

The refrigerant, while passing through the condenser, gives up its latent heat to the surrounding condensing medium which is normally air or water.

### **Receiver**

The condensed liquid refrigerant from the condenser is stored in a vessel known as receiver from where it is supplied to the evaporator through the expansion valve or refrigerant control valve.

### **Expansion Valve**

It is also called throttle valve or refrigerant control valve. The function of the expansion valve is to allow the liquid refrigerant under high pressure and temperature to pass at a controlled rate after reducing its pressure and temperature. Some of the liquid refrigerant evaporates as it passes through the expansion valve, but the greater portion is vaporized in the evaporator at the low pressure and temperature

### **Evaporator**

An evaporator consists of coils of pipe in which the liquid-vapour. refrigerant at low pressure and temperature is evaporated and changed into vapour refrigerant at low pressure and temperature. In evaporating, the liquid vapour refrigerant absorbs its latent heat of vaporization from the medium (air, water or brine) which is to be cooled.

### **Theoretical Vapour Compression Cycle with Dry Saturated Vapour after Compression**

A vapour compression cycle with dry saturated vapour after compression is shown on T-s diagrams in Figures 2.2(a) and (b) respectively. At point 1, let  $T_1$ ,  $p_1$  and  $s_1$  be the temperature, pressure and entropy of the vapour refrigerant respectively. The four processes of the cycle are as follows :

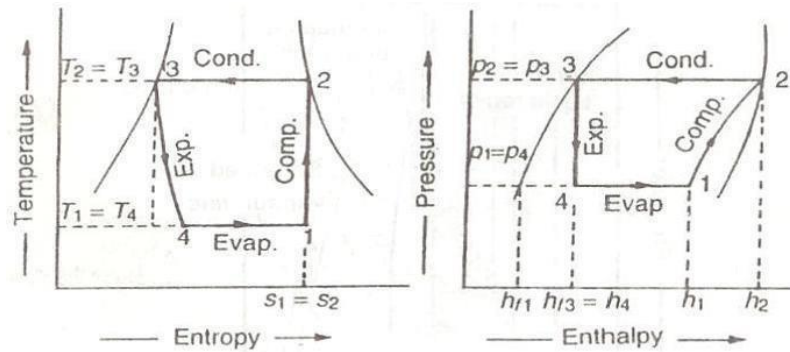

(a) T-s Diagram (b) p-h Diagram

### Theoretical vapour Compression Cycle with Dry Saturated Vapour after Compression

#### Compression Process

The vapour refrigerant at low pressure  $p_1$  and temperature  $T_1$  is compressed isentropically to dry saturated vapour as shown by the vertical line 1-2 on the T-s diagram and by the curve 1-2 on p-h diagram. The pressure and temperature rise from  $p_1$  to  $p_2$  and  $T_1$  to  $T_2$  respectively.

The work done during isentropic compression per kg of refrigerant is given by

$$w = h_2 - h_1$$

where  $h_1$  = Enthalpy of vapour refrigerant at temperature  $T_1$ , i.e. at suction of the compressor, and

$h_2$  = Enthalpy of the vapour refrigerant at temperature  $T_2$ . i.e. at discharge of the compressor.

#### Condensing Process

The high pressure and temperature vapour refrigerant from the compressor is passed through the condenser where it is completely condensed at constant pressure  $p_2$  and temperature  $T_2$  as shown by the horizontal line 2-3 on T-s and p-h diagrams. The vapour refrigerant is changed into liquid refrigerant. The refrigerant, while passing through the condenser, gives its latent heat to the surrounding condensing medium.



### **Expansion Process**

The liquid refrigerant at pressure  $p_3 = p_2$  and temperature  $T_3 = T_2$ , is expanded by throttling process through the expansion valve to a low pressure  $p_4 = p_1$  and Temperature  $T_4 = T_1$  as shown by the curve 3-4 on T-s diagram and by the vertical line 3-4 on p-h diagram. Some of the liquid refrigerant evaporates as it passes through the expansion valve, but the greater portion is vaporized in the evaporator. We know that during the throttling process, no heat is absorbed or rejected by the liquid refrigerant.

### **Vaporizing Process**

The liquid-vapour mixture of the refrigerant at pressure  $p_4 = p_1$  and temperature  $T_4 = T_1$  is evaporated and changed into vapour refrigerant at constant pressure and temperature, as shown by the horizontal line 4-1 on T-s and p-h diagrams. During evaporation, the liquid-vapour refrigerant absorbs its latent heat of vaporization from the medium (air, water or brine) which, is to be cooled, This heat which is absorbed by the refrigerant is called refrigerating effect and it is briefly written as  $RE$ . The process of vaporization continues up to point 1 which is the starting point and thus the cycle is completed.

We know that the refrigerating effect or the heat absorbed or extracted by the liquid-vapour refrigerant during evaporation per kg of refrigerant is given by

$$RE = h_1 - h_4 = h_1 - hf_3$$

where  $hf_3$  = Sensible heat at temperature  $T_3$ , i.e. enthalpy of liquid refrigerant leaving the condenser.

It may be noticed from the cycle that the liquid-vapour refrigerant has extracted heat during evaporation and the work will be done by the compressor for isentropic compression of the high pressure and temperature vapour refrigerant.

Coefficient of performance, C.O.P. = (Refrigerating effect)/( Work done)

The suction pressure (or evaporator pressure) decreases due to the frictional resistance of flow of the refrigerant. Let us consider a theoretical vapour compression cycle 1-2-3-4 when the suction pressure decreases from  $p_s$  to  $p'_s$  as shown on p-h diagram in Figure

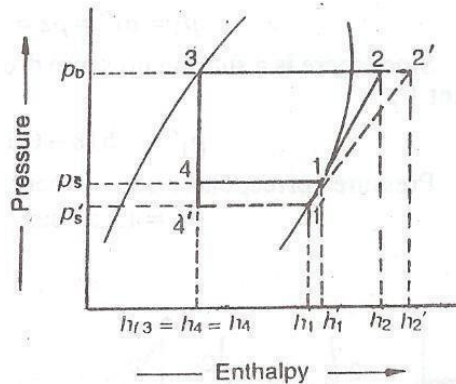

It may be noted that the decrease in suction pressure :

- (a) decreases the refrigerating effect
- (b) Increases the work required for compression

### Effect of Suction Pressure

Since the C.O.P. of the system is the ratio of refrigerating effect to the work done, therefore with the decrease in suction pressure, the net effect is to decrease the

C.O.P. of the refrigerating system for the same refrigerant flow. Hence with the decrease in suction pressure the refrigerating capacity of the system decreases and the refrigeration cost increases.

### Effect of Discharge Pressure

In actual practice, the discharge pressure (or condenser pressure) increases due to frictional resistance of flow of the refrigerant. Let us consider a theoretical vapour compression cycle 1-

when the discharge pressure increases from  $p_D$  to  $p_{D'}$  as shown on p-h diagram in Figure resulting in increased compressor work and reduced refrigeration effect.

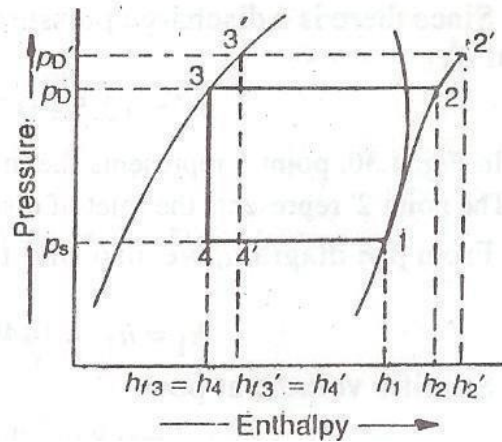

**Effect of Discharge Pressure**

### Conditions for Highest COP

### Effect of Evaporator Pressure

Consider a simple saturation cycle 1-2-3-4 with Freon 12 as the refrigerant as shown in Figure for operating conditions of  $t_k = 40^\circ\text{C}$  and  $t = -5^\circ\text{C}$ .

Now consider a change in the evaporator pressure corresponding to a decrease in the evaporator temperature to  $-10^\circ\text{C}$ .

It is therefore, seen that a drop in evaporator pressure corresponding to a drop of  $5^\circ\text{C}$  in saturated suction temperature increases the volume of suction vapour and hence decreases the capacity of a reciprocating compressor and increases the power consumption per unit refrigeration.

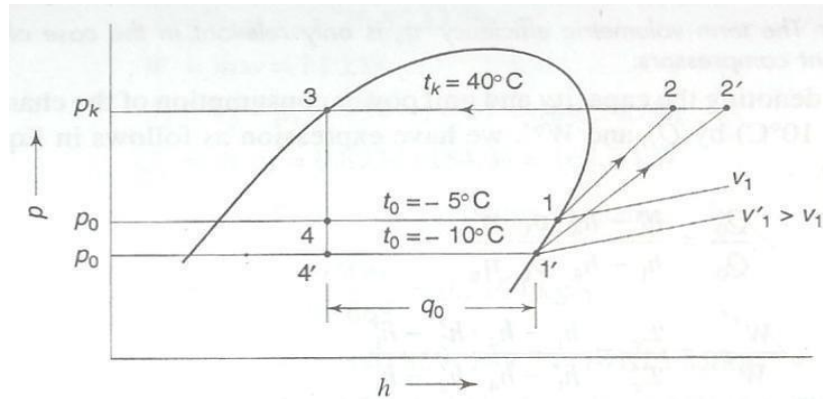

### Effect of Evaporator Pressure

It is observed that a decrease in evaporator temperature results in :

- Decrease in refrigerating effect from
- Increase in the specific volume of suction vapour from
- Decrease in volumetric efficiency, due to increase in the pressure ratio,
- Increase in compressor work due to increase in the pressure ratio as well as change from steeper isentropic to flatter isentropic

### Effect of Condenser Pressure

An increase in condenser pressure, similarly results in a decrease in the refrigerating capacity and an increase in power consumption, as seen from the changed cycle 1 - 2 - 3 - 4 for  $t_k = 45^\circ\text{C}$  in Figure 2.6. The decrease in refrigerating capacity is due to a decrease in the refrigerating effect and volumetric efficiency. The increase in power consumption is due to increased mass flow (due to decreased refrigerating effect) and an increase in specific work (due to increased pressure ratio), although the isentropic line remains unchanged. Accordingly, one can write for the ratios

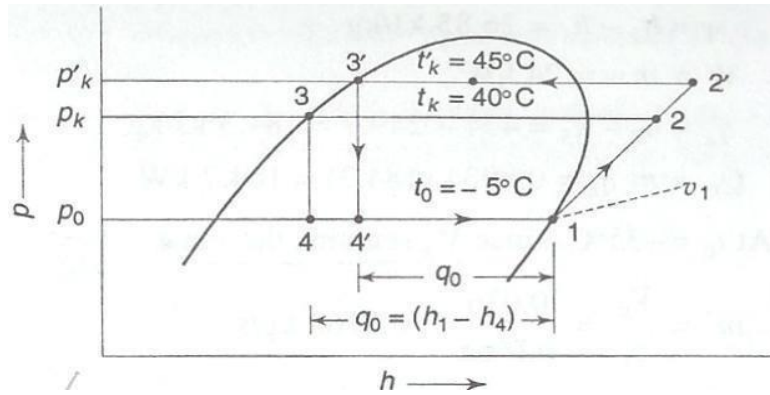

### Effect of Condenser Pressure

It is obvious that COP decreases both with decreasing evaporator and increasing condenser pressures.

It may, however, be noted that the effect of increase in condenser pressure is not as severe, on the refrigerating capacity and power consumption per ton of refrigeration, as that of the decrease in evaporator pressure.

### Effect of Suction Vapour Superheat

Superheating of the suction vapour is advisable in practice because it ensures complete vaporization of the liquid in the evaporator before it enters the compressor. Also, in most refrigeration and air-conditioning systems, the degree of superheat serves as a means of actuating and modulating the capacity of the expansion valve. It has also been seen that for some refrigerants such as Freon 12, maximum COP is obtained with superheating of the suction vapour.

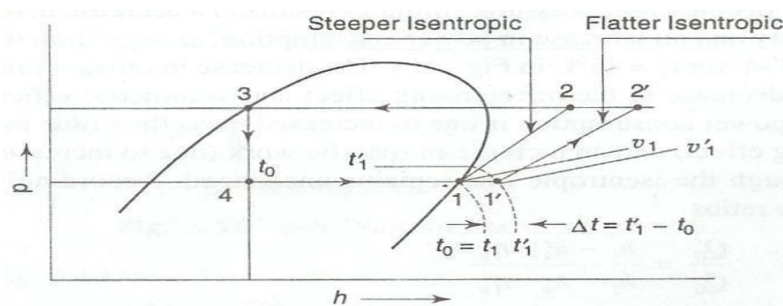

### Effect of Suction Vapour Superheat

It can be seen from Figure 2.7, that the effect of superheating of the vapour from is as follows Increase in specific volume of suction vapour

- (a) Increase in refrigerating effect
- (b) Increase in specific work

This is because, although the pressure ratio is the same for both lines, the initial temperature  $t_{1'}$  is greater than  $t_1$  and the work given by the expression increases with the initial temperature.

That is why isentropic lines on the

diagram become flatter in higher temperatures. An increase in specific volume decreases the capacity. On the contrary, an increase in refrigerating effect will increase the capacity effect of superheating is to theoretically reduce the capacity in ammonia systems and to increase it in Freon 12 systems.

### Effect of Liquid Subcooling

It is possible to reduce the temperature of the liquid refrigerant to within a few degrees of the temperature of the water entering the condenser. In some condenser designs it is achieved by installing a sub-cooler between the condenser and the expansion valve.

The effect of sub-cooling of the liquid is shown in

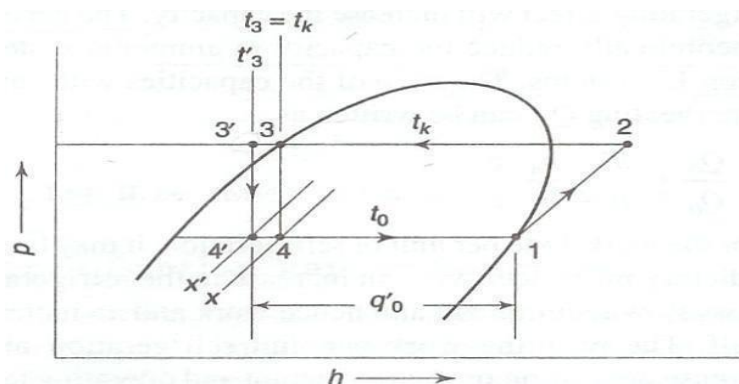

It will be seen that sub-cooling reduces flashing of the liquid during expansion and increases the refrigerating effect. Consequently, the piston displacement and horsepower per ton are reduced for all refrigerants. The percent gain is less pronounced in the case of ammonia because of its larger latent heat of vaporization as compared to liquid specific heat.

### Effect of Liquid Subcooling

Normally, cooling water first passes through the subcooler and then through the condenser. Thus, the coolest water comes in contact with the liquid being subcooled. But this results in a warmer water entering the condenser and hence a higher condensing temperature and pressure. Thus, the advantage of subcooling is offset by the increased work of compression.

This can be avoided by installing parallel cooling water inlets to the subcooler and condenser. In that case, however, the degree of subcooling will be small and the added cost of the subcooler and pump work may not be worthwhile. It may be more desirable to use the cooling water effectively in the condenser itself to keep the condensing temperature as near to the temperature of the cooling water inlet as possible.

### Carnot Refrigeration Cycle

In refrigeration system, the Carnot cycle considered is reversed Carnot cycle. We know that a heat engine working on Carnot engine has the highest efficiency. Similarly, a refrigeration system working on the reversed cycle, has the maximum coefficient of performance.

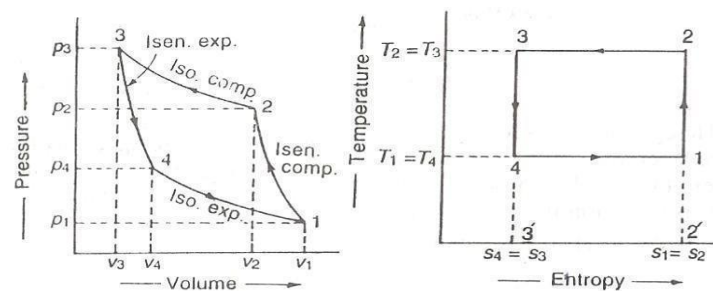

(a) p-v Diagram

(b) T-s Diagram

## Reversed Carnot Cycle

A reversed Carnot cycle, using air as the working medium is shown on  $p$ - $v$  and  $T$ - $s$  diagrams in Figures 2.9(a) and (b) respectively. At point 1, let  $p_1$ ,  $v_1$ ,  $T_1$  be the pressure, specific volume and temperature of air respectively.

The four processes of the cycle are as follows:

### Isentropic Compression Process

The air is compressed isentropically as shown by the curve 1-2 on  $p$ - $v$  and  $T$ - $s$  diagrams. During this process, the pressure of air increases from  $p_1$  to  $p_2$ , specific volume decreases from  $v_1$  to  $v_2$  and temperature increases from  $T_1$  to  $T_2$ . We know that during isentropic compression, no heat is absorbed or rejected by the air.

### Isothermal Compression Process

The air is now compressed isothermally (i.e. at constant temperature,  $T_2 = T_3$ ) as shown by the curve 2-3 on  $p$ - $v$  and  $T$ - $s$  diagrams. During this process, the pressure of air increases from  $p_2$  to  $p_3$  and specific volume decreases from  $v_2$  to  $v_3$ . We know that the heat rejected by the air during isothermal compression per kg of air,

$$= T_3 (s_2 - s_3)$$

$$= T_2 (s_2 - s_3)$$

### Isentropic Expansion Process

The air is now expanded isentropically as shown by the curve 3-4 on  $p$ - $v$  and  $T$ - $s$  diagrams. The pressure of air decreases from  $p_3$  to  $p_4$ , specific volume increases from  $v_3$  to  $v_4$  and temperature decreases from  $T_3$  to  $T_4$ . We know that during isentropic expansion, no heat is absorbed or rejected by the air.



### **Isothermal Expansion Process**

The air is now expanded isothermally (i.e. at constant temperature,  $T_4 = T_1$ ) as shown by the curve 4-1 on  $p-v$  and  $T-s$  diagrams. During this process, the pressure of air decreases from  $p_4$  to  $p_1$  and specific volume increases from  $v_4$  to  $v_1$ . We know that the heat absorbed by the air during isothermal compression per kg of air,

$$= T_4 (s_1 - s_4)$$

$$= T_4 (s_2 - s_3)$$

$$= T_1 (s_2 - s_3)$$

We know that work done during the cycle per kg of air

$$= \text{Heat rejected} - \text{Heat absorbed}$$

$$= q_{2-3} - q_{4-1}$$

$$= T_2 (s_2 - s_3) - T_1 (s_2 - s_3)$$

Therefore, coefficient of performance of the refrigeration system working on reversed Carnot cycle,

$$\text{C.O.P.} = \text{Ratio of Heat Absorbed to Work Done} = \frac{T_2}{T_2 - T_1}$$

### **Limitations for Reversed Carnot Cycle** The C.O.P. of the

reversed Carnot cycle can be improved by

- (b) Decreasing the higher temperature (i.e. temperature of hot body,  $T_2$ ) or
- (c) Increasing the lower temperature (i.e. temperature of cold body,  $T_1$ ).

It may be noted that temperature  $T_1$  and  $T_2$  cannot be varied at will, due to certain functional limitations.

It should be kept in mind that the higher temperature ( $T_2$ ) is the temperature of

cooling water or air available for rejection of heat and the lower temperature ( $T_1$ ) is the temperature to be maintained in the refrigerator. The heat transfer will take place in the right direction only when the higher temperature is more than the temperature of cooling water or air to which heat is to be rejected, while the lower temperature must be less than the temperature of substance to be cooled.

Thus if the temperature of cooling water or air (i.e.  $T_2$ ) available for heat rejection is low, the

will be high. Since  $T_2$  in winter is less than  $T_2$  in summer, therefore, C.O.P. in winter will be higher than C.O.P. in summer. In other words, the Carnot refrigerator works more efficiently in winter than in summer. Similarly, if the lower temperature ( $T_1$ ) is high, the C.O.P. of the Carnot refrigerator will be high.

### **Difference between Refrigeration and Heat Pump System**

The major difference between the refrigeration and heat pump system is that refrigerator delivers heat from lower temperature to a higher temperature, whereas heat pump delivers heat from higher temperature to lower temperature body.

### **VAPOUR COMPRESSION SYSTEMS**

The challenge in refrigeration and air conditioning is to remove heat from a low temperature source and dump it at a higher temperature sink. Compression refrigeration cycles in general take advantage of the idea that highly compressed fluids at one temperature will tend to get colder when they are allowed to expand. If the pressure change is high enough, then the compressed gas will be hotter than our source of cooling (outside air, for instance) and the expanded gas will be cooler than our desired cold temperature. In this case, we can use it to cool at a low temperature and reject the heat to a high temperature.

Vapour-compression refrigeration cycles specifically have two additional advantages. First, they exploit the large thermal energy required to change a liquid to a vapour so we can remove

lots of heat out of our air-conditioned space. Second, the isothermal nature of the vaporization allows extraction of heat without raising the temperature of the working fluid to the temperature of whatever is being cooled. This is a benefit because the closer the working fluid temperature approaches that of the surroundings, the lower the rate of heat transfer. The isothermal process allows the fastest rate of heat transfer

Vapour compression refrigeration is the primary method to provide mechanical cooling. All vapor compression systems consist of the following four basic components alongwith the interconnecting piping. These are the evaporator, condenser, compressor and the expansion valve. Typical vapor compression systems can be represented as shown in figure

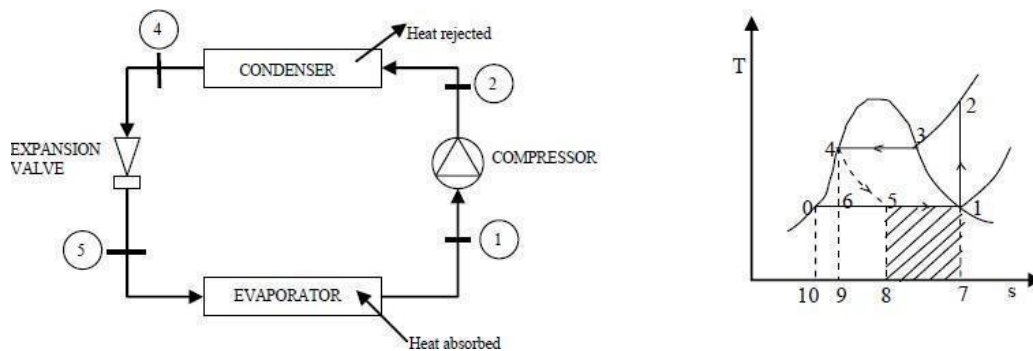

### Schematic Representation of a Vapour Compression System and T-S Diagram

The evaporator and the condenser are heat exchangers that evaporate and condense the refrigerant while absorbing and rejecting the heat. The compressor takes the refrigerant from the evaporator and raises the pressure sufficiently for the vapor to condense in the condenser. The expansion device controls the flow of condensed refrigerant at this higher pressure back into the evaporator. Some typical expansion devices are throttle valves, capillary tubes and thermostatic expansion valves in case of large refrigeration systems.

Figure shows the  $T$ - $S$  plot of the working of such a system. Here, the dry saturated working medium at state 1 is compressed isentropically to state 2.

Constant pressure heat transfer occurs from state 2 until the compressed vapor becomes saturated liquid or condensate at state 4. The compressed vapor is next throttled from the high pressure region in the condenser (state 4) to the low pressure region in the evaporator (state 5). Since throttling is an irreversible process, it is represented by a broken line. After throttling to evaporator pressure, the heat transfer in the evaporator causes vaporization of the working medium until state 1 is reached, thus completing the cycle. The process 4-5 is assumed to be adiabatic during throttling, an isenthalpic process.

### CARNOT VAPOR COMPRESSION SYSTEMS

Here, the compression is imagined to take place in two stages: isentropic compression upto state 2 and isothermal compression from state 2 to 3 as shown in Figure

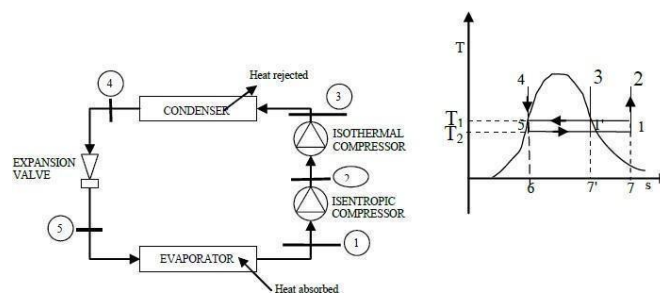

#### Schematic Representation of a Carnot Vapour Compression System and T-S Diagram

The working medium is condensed in a heat exchanger giving saturated liquid at state 4. The isentropic expansion from state 4 to state 5 gives the refrigeration effect, the area under line 5-1.

Comparing figs, we can see that the Carnot vapor compression cycle gives a greater refrigeration effect than the vapor compression cycle. It can be seen that the refrigeration system working on the Carnot vapor compression cycle has the highest COP.

## **LIMITATIONS OF CARNOT VAPOR COMPRESSION SYSTEMS WITH VAPOR AS REFRIGERANT**

Although in theory, the Carnot vapor compression cycle has the highest COP; it is not suited for use in practical refrigeration systems. This is because it is virtually impossible to compress the refrigerant isothermally from state 2 to state 3 in a finite time interval. To offset this difficulty, we can follow the alternate path 1'-3-4-5. However, this results in other difficulties which are mentioned in detail below:

### **Dry vs. Wet Compression**

If the Carnot vapour cycle follows the path 1-2-3-4, then there is dry compression of the refrigeration vapor since the refrigerant is dry saturated at state 1. This type

of compression is desirable in the compressor. But, in this case we see that the refrigerant now has to be compressed isothermally from state 2 to state 3, which is impossible to achieve in practice. The alternate path 1'-3-4-5 involves a wet compression of the vapor from state 1' to state 3. Wet compression is highly undesirable as the compressor now has to deal with two different fluid phases. Besides, the liquid droplets present in the vapor would now react with the lubricant in the compressor which is highly undesirable. Thus, we see that both the paths of the Carnot vapor cycle are not suitable for use in practical refrigeration systems.

### **Throttling vs. Isentropic Compression**

In the Carnot vapour compression cycle, there is isentropic expansion from state 4 to state 5. This is achieved by the use of a turbine. However, in actual cycles, the expansion from saturated liquid at state 4 to liquid-vapor mixture at state 5 produces very little work. A turbine working under such conditions would have very low efficiency which would not justify the cost involved in using a turbine. Also, the refrigeration system would become very bulky and not suitable for domestic use.

In actual practice, an expansion valve is used to achieve the desired expansion from state 4 to state 5. The refrigerant gets throttled in the expansion valve from saturated liquid to liquid- vapor mixture. The expansion no longer remains isentropic. The expansion now becomes an isenthalpic process. Thus, we see that the Carnot vapour refrigeration cycle is not suitable for use in refrigeration systems. A better ideal cycle is the vapor compression refrigeration cycle.

## **UNIT II**

### **COMPONENTS OF V.C.R.S**

## **REFRIGERATION COMPONENTS**

Refrigeration system consists of several equipments like compressor, condenser, evaporator, expansion devices etc. A refrigerant compressor is a machine used to compress the refrigerant from the evaporator and to raise its pressure so that the corresponding temperature is higher than that of the cooling medium. The condenser is an important device used in the high pressure side of a refrigeration system. Its function is to remove heat of the hot vapour refrigerant discharged from the compressor. The evaporator is used in the low pressure side of a refrigeration system. The liquid refrigerant from the expansion device enters into the evaporator where it boils and changes into vapour. The function of an evaporator is to absorb heat from the surrounding location or medium which is to be cooled, by means of a refrigerant. The temperature of the boiling refrigerant in the evaporator must always be less than that of the surrounding medium so that the heat flows to the refrigerant. The expansion device which is also known as throttling device, divides the high pressure side and the low pressure side of a refrigeration system. It is connected between the receiver and the evaporator. Refrigeration system consists of different equipments. Individual knowledge of the equipments is required to understand the refrigeration system. The basic principle of the refrigerant equipments and the classification of those equipments are discussed here.

### **COMPRESSORS**

#### **Types of Compressor**

There are different types of compressors that generally used in industry are,

- (a) Reciprocating compressor
- (b) Centrifugal compressor
- (c) Rotary compressor



- (d) Screw compressor
- (e) Scroll compressor

The reciprocating and screw compressors are best suited for use with refrigerants which require a relatively small displacement and condense at relatively high pressure, such as R-12, R-22, Ammonia, etc.

The centrifugal compressors are suitable for handling refrigerants that require large displacement and operate at low condensing pressure, such as R-11, R-113, etc.

The rotary compressor is most suited for pumping refrigerants having moderate or low condensing pressures, such as R-21 and R-114; this is mainly used in domestic refrigerators.

### **Reciprocating Compressor**

The compressors in which the vapour refrigerant is compressed by the reciprocating (i.e. back and forth) motion of the piston, called reciprocating compressors. These compressors are used for refrigerants which have comparatively low volume per kg and a large differential pressure, such as ammonia, R-12, R-22, etc.

#### *Basic Cycle for Reciprocating Compressor*

The p-v diagram of a reciprocating compressor is shown in the Figure 3.1 along with the skeleton diagram of the cylinder and piston mechanism.

When the piston is in the extreme left position of the inner dead centre (IDC), the volume occupied by the gas is  $V_C = V_3$  called clearance volume,

i.e. the volume between the piston and cylinder head. As the piston moves outward, the clearance gas expands to 4, when the pressure inside the cylinder is equal to the pressure at the suction flange of the compressor. As the piston moves further, the suction valve S opens and

the vapour from the evaporator is sucked in till the extreme right position of the outer dead centre (ODC) is reached. At this position the volume occupied by the gas is  $V_1$ . The stroke or swept volume or piston displacement is

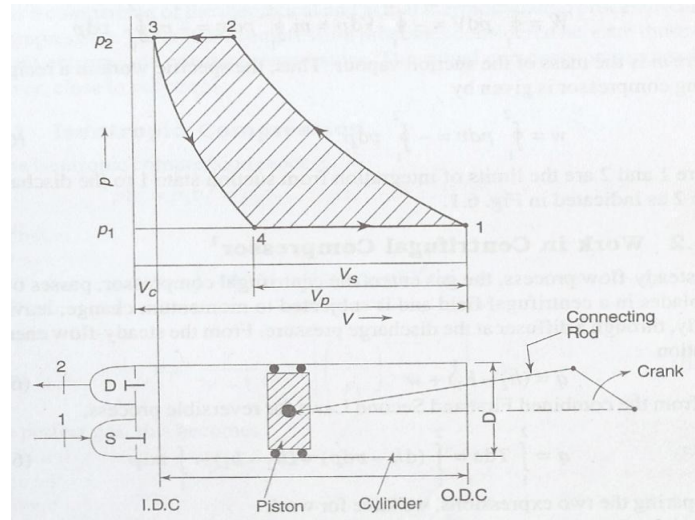

### Cylinder and Piston Mechanism and P-V Diagram of a Reciprocating Compressor

Where  $D$  is the bore or diameter and  $L$  is the stroke, i.e. the distance traveled by the piston between IDC and ODC of the cylinder. At 1, the suction valve closes as the piston moves inwards and the compression begins. At 2, the pressure in the cylinder is equal to the pressure at the discharge flange of the compressor. A further movement of the piston inward results in the pressure in the cylinder exceeding the condenser pressure. This opens the discharge valve  $D$  and the vapour from the cylinder flows into the condenser till the piston reaches again the IDC position. Gas equal to the clearance volume  $V_c$  remains in the cylinder and the cycle is operated. The work done for compression is given by the cyclic integral of  $pdV$ .

#### *Volumetric Efficiency of Reciprocating Compressor*

Volumetric efficiency is the term defined in the case of positive displacement compressors to account for the difference in the displacement in-built in the compressor  $V_p$  and actual volume  $V_s$ , of the suction vapour sucked and pumped.

### *Clearance Volumetric Efficiency*

The clearance or gap between the I.D.C. position of the piston and cylinder head is necessary in reciprocating compressors to provide for thermal expansion and machining tolerances. A clearance of  $(0.005L+0.5)$  mm is normally provided. This space together with the volume of the dead space between the cylinder head and valves, forms the clearance volume. The ratio of the clearance volume  $V_c$  to the swept volume  $V_b$  is called the clearance factor  $C$ , This factor is normally  $\leq 5$  per cent. The effect of clearance in reciprocating compressors is to reduce the volume of the sucked vapour, as can be seen from Figure. The gas trapped in the clearance space expands from the discharge pressure to the suction pressure and thus fills a part of the cylinder space before suction begins.

### *Variation of Volumetric Efficiency with Suction Pressure*

As shown in Figure 3.2 the nature of variation of the p-V diagram of a reciprocating compressor with suction pressure for constant discharge pressure. It is seen that with decreasing suction pressure, or increasing pressure ratio, the suction volume  $V$  and hence volumetric efficiency decrease until both become zero at a certain low pressure  $p'$ . Thus the refrigerating capacity of a reciprocating compressor tends to zero with decreasing evaporator pressure.

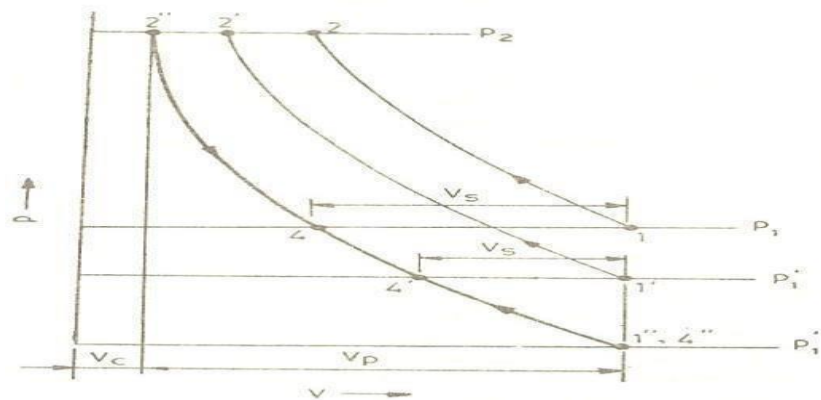

**Decrease in Suction Volume in a Reciprocating Compressor with Decreasing Evaporator Pressure**

### *Effect of Valve Pressure Drops*

For the flow of any fluid, the pressure must drop in the direction of flow. Both suction and discharge valves will open only when there is a pressure drop across them. The effect of these pressure drops on the indicator diagram of the compressor is shown in Figure 3.3. It is seen that as a result of throttling or pressure drop on the suction side the pressure inside the cylinder at the end of the suction stroke is  $P_s$  while the pressure at the suction flange is  $P_1$ . The pressure in the cylinder rises to the suction flange pressure  $P_t$  only after the piston has travelled a certain distance inward during which the volume of the fluid has decreased.

Assuming the compression index to be  $n$  instead of  $\gamma$ , as the compression process is also polytropic due to heat exchange with cylinder walls and friction, we have

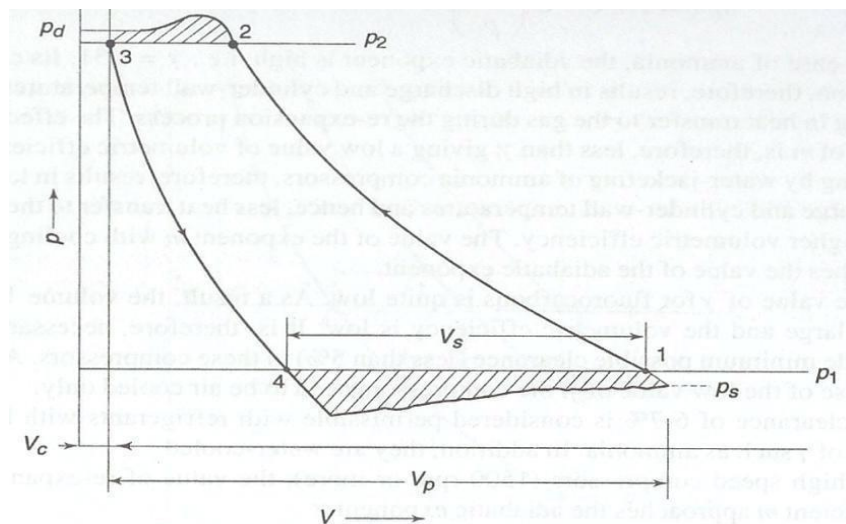

### **Effect of Valve Pressure Drops**

#### *Overall Volumetric Efficiency*

Considering the effect of wire-drawing at the valves, polytropic compression, re-expansion, and leakage, we may write the expression for the overall or total volumetric efficiency

The methods of improving the volumetric efficiency include the following:

- (a) Providing clearance as small as possible,
- (b) Maintaining low pressure ratio,
- (c) Cooling during compression,
- (d) Reducing pressure drops at the valves by designing a light- weight valve mechanism, minimizing valve overlaps and choosing suitable lubricating oils.

#### *Effect of Clearance on Work*

The effect of the clearance volume on the work of compression is mainly due to the different values of the exponents of the compression and expansion processes.

Thus the work is only proportional to the suction volume. The clearance gas merely acts like a spring, alternately expanding and contracting. In practice, however, a large clearance volume results in a low volumetric efficiency and hence large cylinder dimensions, increased contact area between the piston and cylinder and so, increased friction and work.

#### **Centrifugal Compressor**

A single-stage centrifugal compressor mainly consists of the following four components as shown in Figure 3.4.

- (f) An inlet casing to accelerate the fluid to the impeller inlet.
- (g) An impeller to transfer energy to the fluid in the form of increase in static pressure and kinetic energy.
- (h) A diffuser to convert the kinetic energy at the impeller outlet into pressure energy (static enthalpy).
- (i) A volute casing to collect the fluid and to further convert the kinetic energy into pressure energy (static enthalpy).

Besides these, there are intercoolers, generally integrated with the casing, in a multistage compressor. The casing is usually made of cast iron and the impeller, of alloy (chrome-nickel) steels. The maximum stress is developed at the root of the blades.

The diffuser is normally vaneless type as it permits more efficient part load operation which is quite usual in any air-conditioning plant. A vaned diffuser will certainly cause shock losses if the compressor is run at reduced capacity and flow.

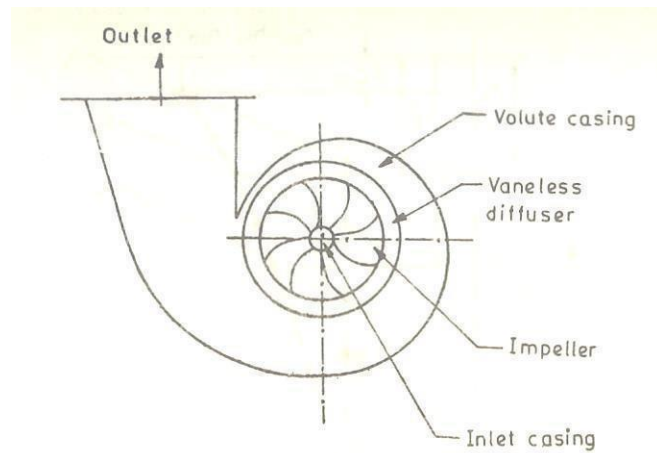

**Elements of a Centrifugal Compressor**

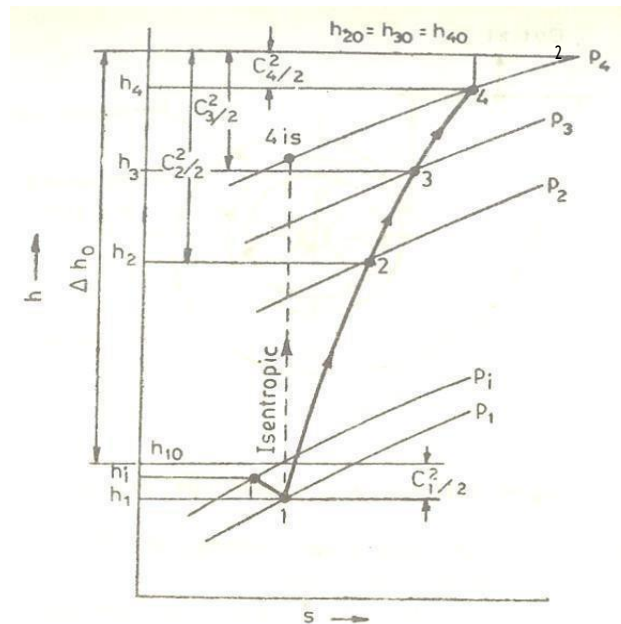

**Mollier Diagram of Centrifugal Stage**

From the point of view of optimal design, an outlet blade angle of  $32^\circ$  is normally preferred. A simple design will, however, have radial blades.

Figure shows the theoretical head-flow characteristic for the three cases of angle  $\beta_2$ . For the case of backward-curved blades, it is a drooping characteristic.

The actual characteristic can, however, be obtained by considering the following losses as shown in Figure

- (a) Leakage loss  $L_1$  proportional to the head.
- (b) Friction loss  $L_2$  proportional to and hence  $Q^2$
- (c) Entrance loss  $L_3$  due to turning of the fluid to enter the impeller, being zero at the design point, which also corresponds to maximum efficiency.

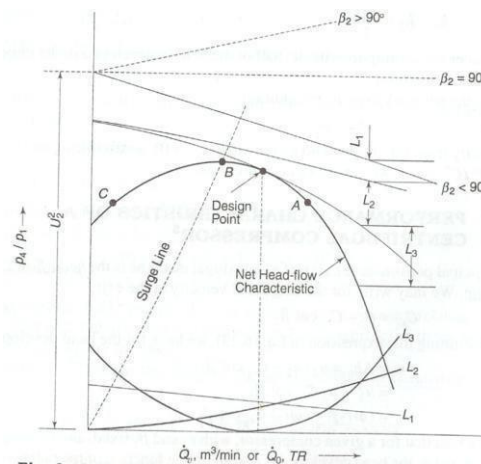

### Performance Characteristic and Losses of a Centrifugal Compressor

#### Surging

Consider A as the point of operation at full load. When the refrigeration load decreases, the point of operation shifts to the left until point B of maximum head is reached. If the load continues to decrease to the left of B, say to C, the pressure ratio developed by the compressor

becomes less than the ratio required between the condenser and evaporator pressure. The point of operation suddenly shifts to A. As the refrigeration load is still less, the cycle will repeat itself. This phenomenon of reversal of flow in centrifugal compressors is called surging. It occurs when the load decreases to below 35 per cent of the rated capacity and causes severe stress conditions in the compressor as a result of hunting.

### **Capacity Control of Centrifugal Compressors**

Centrifugal compressors require high tip speeds to develop the necessary pressure ratio. The high tip speed is achieved by employing either a large diameter impeller or high rpm or both. Because of large  $u^2$ , the velocities in general including the flow velocity  $C$  are high. Also, there must be a reasonable width of the shrouds to minimize friction and achieve high efficiency. Thus, because of the sufficiently large flow area (diameter  $D$  and width of shrouds  $b$ ) required and large flow velocity, the satisfactory volume that can be handled by a centrifugal compressor is about 30-60 cubic metres per minute. A single centrifugal compressor, therefore, can be designed for a minimum capacity approximately of the order of 250 TR with R 11 and 150 TR with R 113 for the purpose of air conditioning.

One of the methods to control the capacity of the compressors is by varying the compressor speed through a speed-reduction gear. The decrease in speed results in an operation on a lower head-flow characteristic giving a lower volume flow rate corresponding to the same pressure ratio.

Capacity can be controlled by the use of variable inlet whirl vanes that are frequently employed with a constant speed drive. The capacity is varied by changing the angle at which the gas enters the impeller. The gas then enters with pre-rotation and this results in a decrease in flow.



## Rotary Compressor

Rotary compressors are positive displacement, direct-drive machines. There are essentially two designs of this compressor:

- (j) Rolling piston type
- (k) Rotating vane type

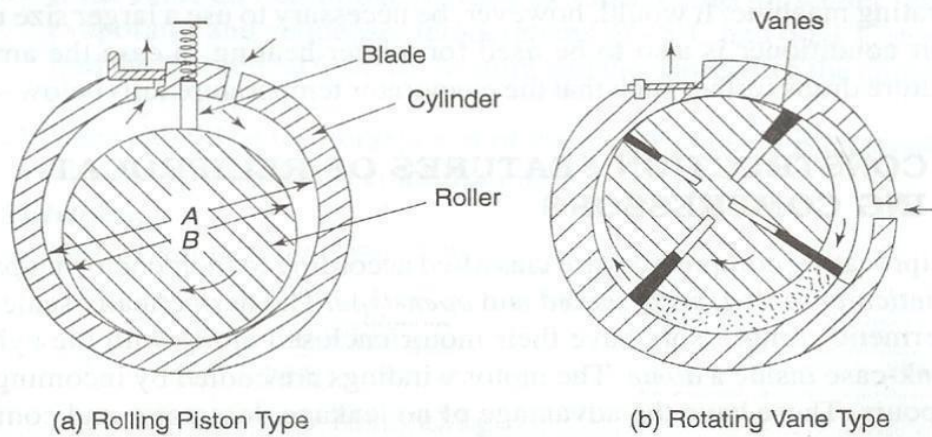

## Rotary Compressor

In the rolling piston type, shown in Figure (a) the roller is mounted on an eccentric shaft with a single blade, which is always in contact with the roller by means of a spring. In the rotating vane type, as shown in Figure (b) with four vanes, the rotor is concentric with the shaft. The vanes slide within the rotor but keep contact with the cylinder. The assembly of rotor and the vanes is off-centre with respect to the cylinder.

In both designs, the whole assembly is enclosed in a housing (not shown in the figures), filled with oil and remains submerged in oil. An oil film forms the seal between the high-pressure and the low-pressure sides. When the compressor stops, this seal is lost and the pressure equalizes.

Rotary compressors have high volumetric efficiencies due to negligible clearance. They are normally used in a single stage up to a capacity of 5 TR with R-114.

Large rotary compressors are used in low-temperature fields, such as in chemical and industrial processing, cold storages and freezing, as high displacement. low- stage or booster compressors at -90 to -100°C evaporator temperature with R-12, R-22 and ammonia. They are available in 10 to 600 hp sizes with 2 to 120 cubic metres per minute displacement in one unit.

### **Screw Compressor**

Rotary screw compressors also belong to the category of positive displacement compressors machine a rotary compressor essentially consists of two helically- grooved rotors as illustrated in Figure which rotate in a housing.

The male rotor consists of lobes and is normally the driving rotor. The female rotor has gullies and is normally the driven rotor. A four-lobe male rotor will drive a six-gully female rotor at two-thirds of its speed.

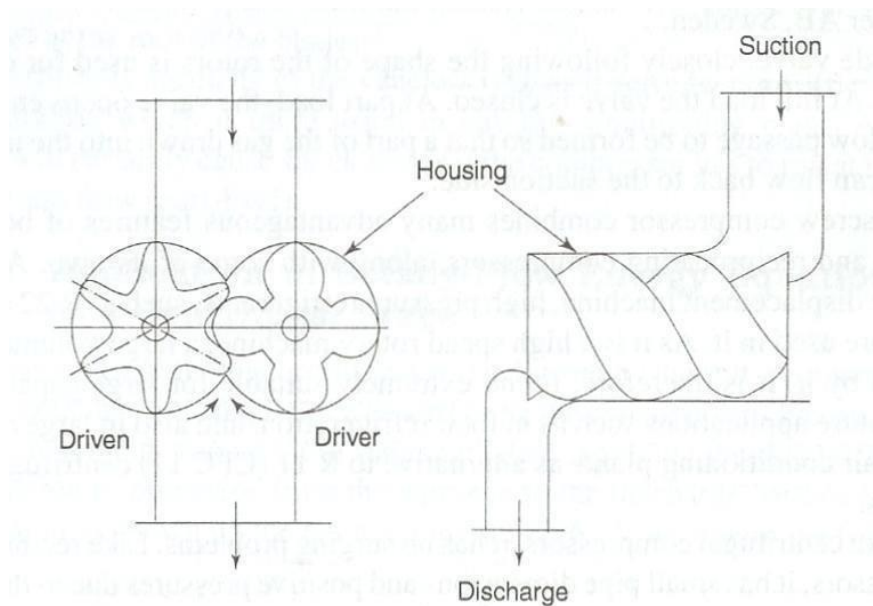

**Sectional and Side Views of a Screw Compressor**

As in the case of other positive displacement machines, there are three basic continuous phases of the working cycle, viz., suction, compression and discharge. When the male rotor turns clockwise, an interlobe space between a pair and housing nearest to the suction end opens and is filled with the gas. There are four such pairs to be filled during one revolution in a four-lobe rotor and the suction periods overlap one another.

When remeshing starts, the volume decreases and the pressure rises. The charge is moved helically and compressed until the trapped volume reaches the discharge end. The compression ratio is thus fixed.

Further rotation simply empties the rotors of the high pressure gas until the last traces of the gas are squeezed out, irrespective of the pressure in the condenser.

On completion of the discharge phase, there is no residual gas remaining in the rotors. As a result, there is no expansion of clearance gases. The compressor has no suction and discharge valves.

There are leakage paths in a screw compressor mainly across the line of mesh between the rotors and across the clearance between the rotors and the housing. To eliminate leakage, oil is injected in a number of small jets directed towards the mesh. Oil injection also serves the purpose of cooling and lubricating along with that of sealing the leakage paths.

A slide valve, closely following the shape of the rotors is used for capacity control. At full load the valve is closed. At part load, the valve opens enabling a return flow passage to be formed so that a part of the gas drawn into the interlobe spaces can flow back to the suction side.

The screw compressor combines many advantageous features of both centrifugal and compressors, along with some of its own. As it is a positive displacement machine, high pressure refrigerants, such as R-22 and ammonia are used in it. As it is a high speed rotary

machine, a large volume can be handled by it. It is, therefore, found extremely suitable for large capacity low temperature applications such as in food refrigeration.

Like reciprocating compressors, it has no surging problems. It has small pipe dimensions and positive pressures due to the use of high pressure refrigerants. Like centrifugal compressors, it has high compression efficiency, continuous capacity control, unloaded starting and no balancing problems. Also, the compressor is suitable for large capacity installations.

## **CONDENSER**

The functions of the condenser are to desuperheat the high pressure gas, condense it and also sub-cool the liquid.

Heat from the hot refrigerant gas is rejected in the condenser to the condensing medium-air or water. Air and water are chosen because they are naturally available. Their normal temperature range is satisfactory for condensing refrigerants.

Like the evaporator, the condenser is also heat-exchange equipment.

### **Types of Condenser**

There are three types of condensers, viz.

- (a) Air-cooled,
- (b) Water-cooled and
- (c) Evaporative.

As their names imply, air-cooled condensers use air as the cooling medium, water-cooled condensers use water as the medium and the evaporative condenser is a combination of the above, i.e. uses both water and air.

### **Air-Cooled Condensers**

There are two types under this category, viz. (a) natural convection and (b) forced-air type.

### **Natural Convection Condenser**

Air movement over the surface of condenser tubes is by natural convection. As air comes in contact with the warm-condenser tubes, it absorbs heat from the refrigerant and thus the temperature of the air increases. Warm air being lighter, rises up and in its place cooler air from below rises to take away the heat from the condenser. This cycle goes on. Since air moves very slowly by natural convection, the rate of flow of heat from the refrigerant to air will be small. Thus a natural convection condenser is not capable of rejecting heat rapidly. Therefore a relatively large surface area of the condenser is required. Hence the use of this type of condenser is limited to very small units such as domestic refrigerators. It, however, requires very little maintenance.

In the small units, the condenser is fixed at the rear of the refrigerator cabinets. Generally, steel tubes are used, steel being cheaper than copper. To increase the heat-transfer area, wires are welded to the condenser tubes. These wires provide mechanical strength to the coil as well. In certain designs, widely-spaced fins are used. It is necessary to space the fins quite widely to avoid resistance to free (natural convection) air movement over the condenser.

Still another design is the plate-type. The condenser coil is fastened to a plate. The plate being in contact with the condenser tubes, the surface area of the condenser is increased. The plate-type condenser is mounted on the back of the refrigerator cabinet with a small gap between the cabinet and the plate. This gap gives an air-flue effect and facilitates better natural convection air currents.

It is obvious that while locating refrigerators or deep-freezes cabinets with a natural convection condenser fixed on the cabinet, sufficient care should be taken to allow free air movement. Also they should not be near an oven or any warm location.

### **Forced-air Circulation Condenser**

This type employs a fan or blower to move air over the condenser coil at a certain velocity. The condenser coil is of the finned type. Fins in such coils are closely spaced (ranging between 8 and 17 fins per inch). The space between the fins gets choked with dirt and lint. Therefore to obtain optimum capacity, the fins should be kept clean. For circulating air over the condenser, fans are mounted on the shaft/pulley of the compressor motor.

For bigger-capacity plants a separate motor is used to drive the fan or blower as also for hermetic-compressor units.

### **Water Cooled Condensers**

There are three types of condensers which fall under this category:

- (d) tube-in-tube or double pipe,
- (e) shell-and-coil, and
- (f) shell-and-tube.

### **Tube-in-Tube or Double Pipe Condenser**

In this type, a smaller diameter pipe inserted inside a bigger diameter pipe is bent to the desired form. Water flows through the inner tube and the refrigerant through the annular space between the two tubes; the flow of refrigerant and water being arranged in opposite direction to get the maximum benefit of heat-transfer. Due to the impurities present in water, scale can form on the

water-side of the tube which can impede the heat transfer; also muck can settle on the surface. Therefore it becomes necessary to periodically clean the water tube. But in the tube-in-tube system, cleaning is not easy, unless a removable header is provided to connect all the tubes.

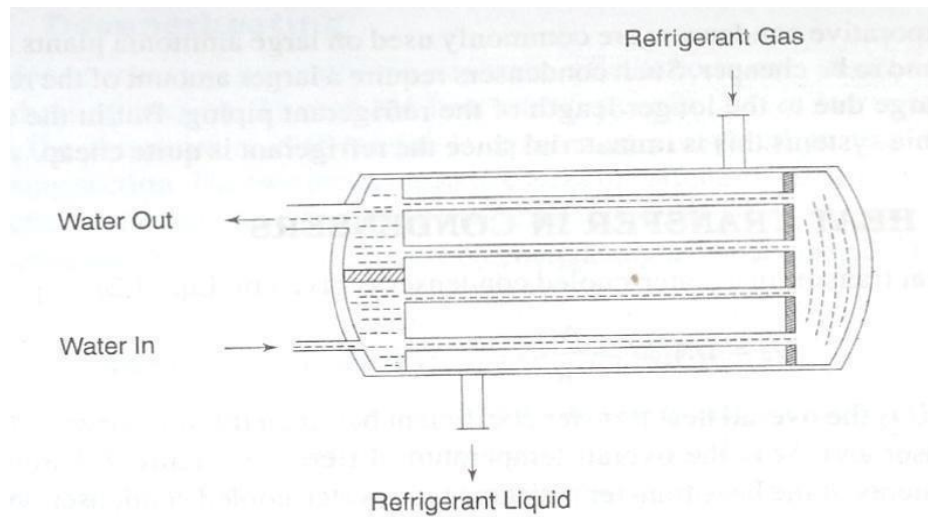

### **Schematic Representation of a Two-Pass Water-Cooled Shell and Tube Condenser Shell-and-Coil Condenser**

It consists of a welded-steel shell containing a coil of finned tubing. Water flows in the coil, the refrigerant being in the shell. Since the tube bundle is in the form of a coil, the water-side of the tube cannot be brushed but can only be cleaned chemically.

### **Shell-and-Tube Condenser**

Figure 3.9 shows a typical shell-and-tube condenser. This is similar in construction to the flooded chiller. A number of straight tubes with integral fins are stacked inside a cylindrical shell, the tube ends expanded into tube sheets which are welded to the shell at both the ends. Intermediate tube supports are provided in the shell to avoid sagging and rattling of the tubes. Since it is very easy to clean the water-side and also, it can be easily repaired, this type of water-cooled condenser is very popular. Since ammonia affects copper, steel tubes are used for ammonia condensers.

Water flows through the condenser water tubes while the refrigerant remains in the shell.

Since copper has a high thermal expansion and contraction rate, the tube tends to move back and forth in the tube sheets due to the variations in temperature.

To prevent the tubes from getting loose at the rolled ends due to this action, the holes in the tube sheets have small grooves. They are only a few hundredths of mm deep. When the tube ends are rolled or expanded in the tube-sheet holes, the copper tubes also expand into the grooves, thereby effectively anchoring the tube ends to the tube sheets and preventing movement of the tubes at the ends. However the expansion forces can cause the tubes to bow.

Removable water boxes are provided at the ends of the condenser to facilitate brushing of the water tubes.

Hot (superheated) refrigerant gas enters at the top of the shell and gets cooled (desuperheated) and condensed as it comes in contact with the water tubes. The condensed liquid drains off to the bottom of the shell. In some condensers extra rows of water tubes are provided at the lower end of the condenser for sub-cooling the liquid below the condensing temperature.

Often the bottom portion of the condenser also serves as the receiver, thereby eliminating the necessity of a separate receiver. However, if the maximum storage capacity (for the refrigerant) of the condenser is less than the total charge of the system, a receiver of adequate capacity has to be added in case the pump down facility is to be provided—such as in ice-plants, cold-storage jobs, etc.

Care should be taken not to overcharge the system with the refrigerant. This is because an excessive accumulation of liquid in the condenser tends to cover too much of the water tubes and reduce the heat-transfer surface available for condensing the high-pressure gas. This results in increasing the head pressure and condensing temperature, and excessive overcharge can create hydraulic pressures.



A fusible plug or safety pressure relief valve is fixed on the shell of the condenser to protect the high side of the refrigeration system against excessive pressures.

### **Evaporative Condenser**

These condensers have some features of both air-and water-cooled types. Both air and water are employed as a condensing medium. Water is pumped from the sump of the evaporative condenser to a spray header and sprayed over the condenser coil. At the same time a fan thaws air from the bottom-side of the condenser and discharges it out at the top of the condenser. An eliminator is provided above the spray header to stop particles of water from escaping along with the discharge air. The spray water coming in contact with the condenser tube surface evaporates into the air stream. The source of heat for vaporizing the water is taken from the refrigerant, thereby condensing the gas.

The evaporative condenser combines the functions of the water-cooled condenser and the cooling tower and hence occupies less space. Moreover, it needs less power than a water-cooled condenser. But the most troublesome point about the evaporative condenser is the difficulty in keeping the surface of the condenser coil clean. The condenser coil being both hot and wet in operation, the dirt carried along with the air stream forms a hard layer on the condenser. Scale also forms a hard layer if hard water is used. Once these hard layers are allowed to form, it is never possible to effectively clean the coil. So the capacity of the condenser gets substantially affected. Because of this maintenance problem, evaporative condensers are not much in favour.

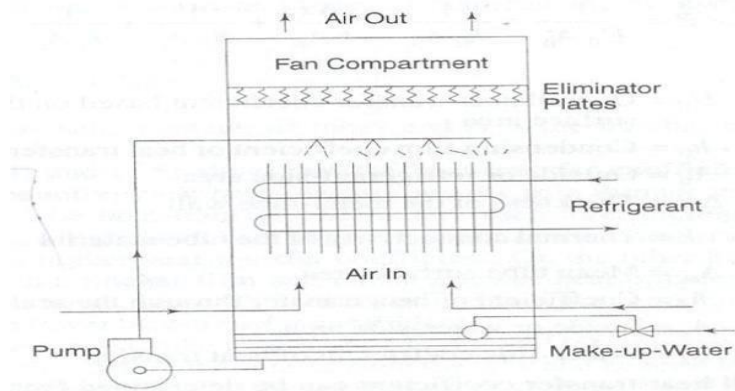

### Evaporative Condenser

#### Heat Transfer in Condensers

The heat transfer in a water-cooled condenser is described where  $U$  is the overall heat transfer coefficient based on the surface area  $A$  of the condenser and  $\Delta t$  is the overall temperature difference. Figure shows the components of the heat-transfer resistance in a water-cooled condenser, viz., the outside refrigerant film, metal wall, scaling on water-side surface and inside- water film. The overall resistance is obtained by adding all the resistances which are in series.

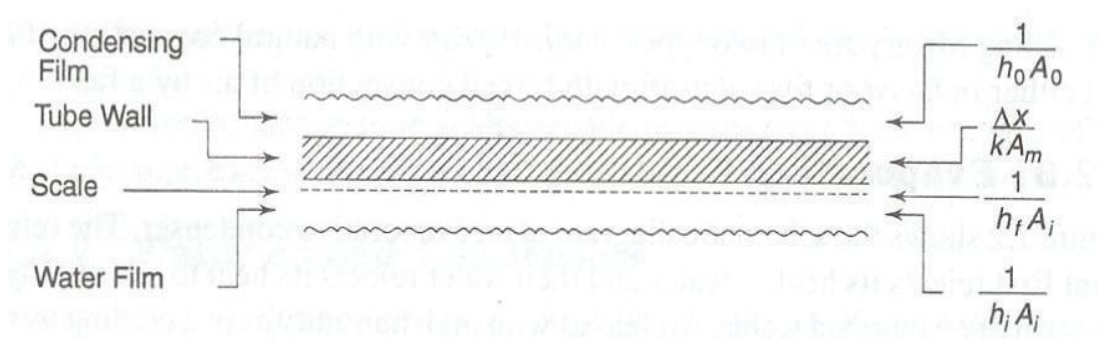

#### Thermal Resistance in Water-Cooled Condenser

$U_0$  = Overall heat-transfer coefficient based on the outside surface area  $h_0$  = Condensing film coefficient of heat transfer

$A_0$  = Outside or refrigerant-side area

$k$  = Thermal conductivity of the tube material  $A_m$  = Mean tube surface area

$h_f$  = Coefficient of heat transfer through the scale  $A_i$  = Inside or water-side area  $h_j$  =

Water-side coefficient of heat transfer.

Thus the overall heat-transfer coefficient can be determined from the above Equation 3.19 after estimating the individual resistances.

## **EVAPORATORS**

The process of heat removal from the substance to be cooled or refrigerated is done in the evaporator.

The liquid refrigerant is vaporized inside the evaporator (coil or shell) in order to remove heat from a fluid such as air, water etc.

Evaporators are manufactured in different shapes, types and designs to suit a diverse nature of cooling requirements. Thus, we have a variety of types of evaporators, such as prime surface types, finned tube or extended surface type, shell and tube liquid chillers, etc.

### **Types of Evaporator**

Evaporators are classified into two general categories-the 'dry expansion' evaporator and 'flooded' evaporator.

#### **Dry Expansion Evaporator**

In the dry-expansion evaporator, the liquid refrigerant is generally fed by an expansion valve. The expansion valve controls the rate of flow of refrigerant to the evaporator in such a way that all the liquid is vaporized and the vapour is also superheated to a limited extent by the time it reaches the outlet end.

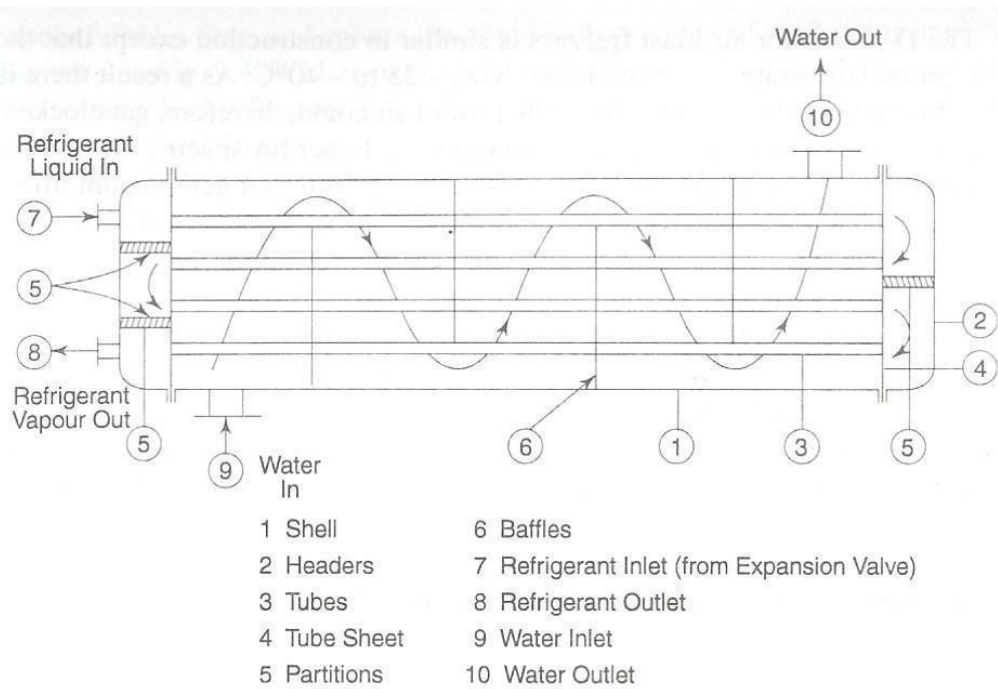

### Direct Expansion Evaporator

Refrigerant is predominantly in the liquid form with a small amount of vapour formed as a result of flashing at the expansion valve. As the refrigerant passes through the evaporator, more and more liquid is vaporized by the load. The refrigerant, by the time it reaches the end of the evaporator, is purely in the vapour state and that too superheated. Thus the evaporator in its length is filled with a varying proportion of liquid and vapour. The amount of liquid in the evaporator will vary with the load on the evaporator. The inside of the evaporator is far from 'dry' but wetted with liquid. All the same, this type is called the 'dry-expansion' system to distinguish it from the 'flooded' system and also probably because by the time the refrigerant reaches the evaporator outlet it is no more wet (no liquid) but dry (superheated) vapour.

### Flooded Evaporator

In a flooded-type evaporator a constant refrigerant liquid level is maintained. A float valve is used as the throttling device which maintains a constant liquid level in the evaporator. Due to the heat supplied by the substance to be cooled, the liquid refrigerant vaporizes and so the liquid

level falls. The float valve opens to admit more liquid and thus maintains a constant liquid level. As a result, the evaporator is always filled with liquid to a level as determined by the float adjustment and the inside surface is wetted with liquid. Thus this type is called the flooded evaporator. The heat-transfer efficiency increases because the entire surface is in contact with the liquid refrigerant and, therefore, the flooded evaporator is more efficient. But the refrigerant charge is relatively large as compared to the dry-expansion type. As the evaporator is filled with liquid, it is obvious that the vapour from the evaporator will not be superheated but will be at saturation. To prevent liquid carry over to the compressor, accumulators' are generally used in conjunction with flooded evaporators. The accumulator also serves as the chamber for the liquid level float valve. The evaporator coil is connected to the accumulator and the liquid flow from the accumulator to the evaporator coil is generally by gravity. The vapour formed by the vaporization of the liquid in the coil being lighter, rises up and passes on to the top of the accumulator from where it enters the suction line as shown in Figure 3.13. In some cases, liquid eliminators are provided in the accumulator top to prevent the possible carry-over of liquid particles from the accumulator to the suction line. Further, a liquid-suction heat exchanger is used on the suction line to superheat the suction vapour. For some applications, a refrigerant liquid pump is employed for circulating the liquid from the accumulator to the evaporator coil and such a system is called a 'liquid-overfeed system'.

While the terms 'dry expansion' and 'flooded' indicate the manner in which the liquid refrigerant is fed into the evaporator and circulated, the terms 'natural convection' and 'forced convection' describe the way in which the fluid (air or liquid) is cooled/circulated around the evaporator.

Natural convection relies on the movement in a fluid, where the colder layer at the top being heavier falls down and the warmer layer rises up. By keeping an evaporator in the topmost portion of an insulated cabin, the air inside the cabin gets cooled by natural convection. A

domestic refrigerator is a typical example. In 'forced-convection' types, the fluid is 'forced' over the evaporator by means of a fan or a liquid pump. In a room air conditioner, a fan continuously circulates the room air over the cooling coil and thus cools the room air. In a chilled-water system, a water pump or brine pump circulates the fluid through the chiller and cooling coils. For a 'coil-in-tank' arrangement, such as in an ice plant, an agitator is used to move the brine over the cooling coil with a certain amount of velocity.

### **Heat Transfer in Evaporators**

The three heat-transfer resistances in evaporators are:

- (a) Refrigerant side for the transfer of heat from solid surface to the liquid refrigerant.
- (b) Metal wall.
- (c) Cooled-medium side which could be due to air, water, brine or any other fluid or a wetted surface on a cooling and dehumidifying coil.

The heat transfer from solid surface to the evaporating refrigerant is of primary interest here. However, the mechanism of boiling is so complex because of the influence of such factors as surface tension, saturation temperature, latent heat and nature of the solid surface, in addition to the usual transport properties, that it is very difficult to predict the heat-transfer coefficient analytically. Nevertheless, no attempt is made here to present correlations applicable to evaporating refrigerants which are available in the large amount of published information available on the subject.

In commercial equipment, the boiling process occurs in two types of situations: one, of pool boiling as in flooded evaporators with refrigerant boiling the shell- side and the other, of flow

or forced convection boiling as in direct- expansion evaporators with refrigerant on the tube- side.

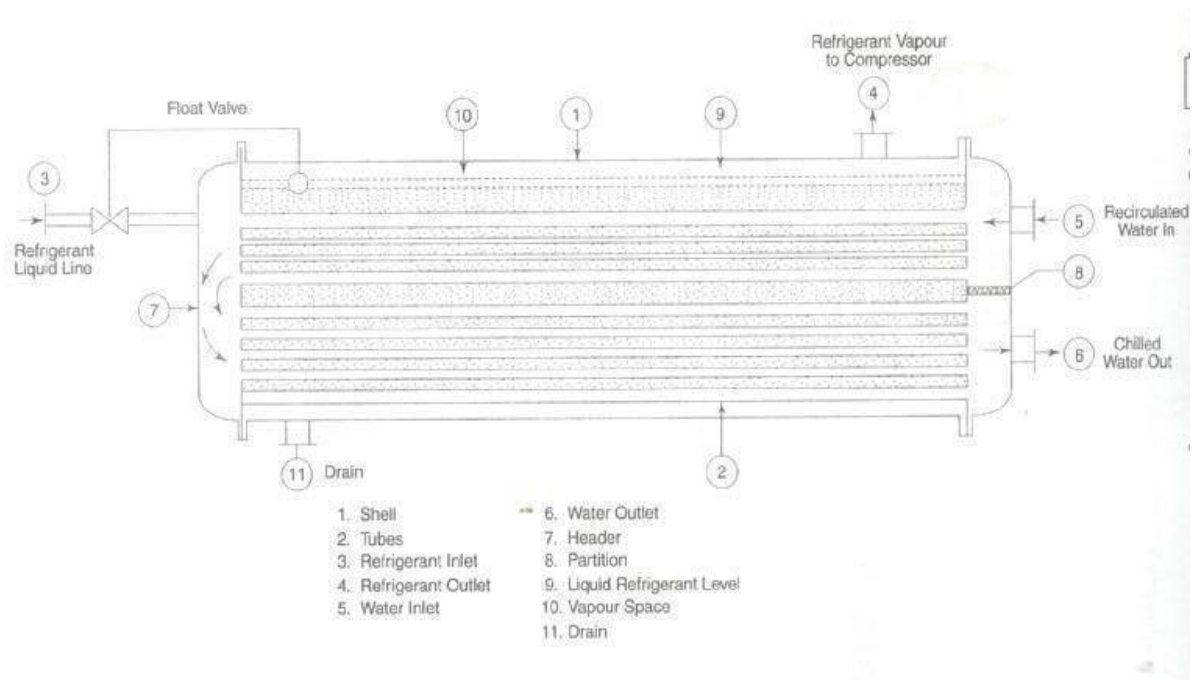

### Flooded Evaporator

#### EXPANSION DEVICES

There are different types of expansion or throttling devices. The most commonly used are:

- (a) Capillary tube,
- (b) Float valves,
- (c) Thermostatic expansion valve.

#### Capillary Tube

Instead of an orifice, a length of a small diameter tube can offer the same restrictive effect. A small diameter tubing is called 'capillary tube', meaning 'hair-like'. The inside diameter of the capillary used in refrigeration is generally about 0.5 to 2.28 mm (0.020 to 0.090'). The longer the capillary tube and/or the

smaller the inside diameter of the tube, greater is the pressure drop it can create in the refrigerant flow; or in other words, greater will be the pressure difference needed between the high side and low side to establish a given flow rate of the refrigerant.

The length of the capillary tube of a particular diameter required for an application is first roughly determined by empirical calculations. It is then further correctly established by experiments. The capillary tube is not self-adjusting. If the conditions change, such as an increase in the discharge/condenser pressure due to a rise in the ambient temperature, reduction in evaporator pressure, etc. the refrigerant flow-rate will also change. Therefore a capillary tube, selected for a particular set of conditions and load will operate somewhat less efficiently at other conditions. However if properly selected, the capillary tube can work satisfactorily over a reasonable range of conditions.

As soon as the plant stops, the high and low sides equalize through the capillary tube. For this reason, the refrigerant charge in a capillary tube system is critical and hence no receiver is used. If the refrigerant charge is more than the minimum needed for the system, the discharge pressure will go up while in operation. This can even lead to the overloading of the compressor motor. Further, during the off- cycle of the unit, the excess amount will enter the cooling coil and this can cause liquid flood back to the compressor at the time of starting. Therefore, the refrigerant charge of the capillary tube system is critical. For this reason, a refrigerant liquid receiver cannot be used. The charge should be exactly the quantity as indicated by the manufacturer of the refrigeration unit.

Since the capillary tube equalizes the high side with the low side during the off- cycle, the idle pressures at the discharge and suction of the compressor will be equal. Therefore at the time of starting, the compressor motor need not overcome the stress of the difference of pressure in the



suction and the discharge sides. In other words the compressor is said to start unloaded. This is a great advantage as a low starting torque motor is sufficient for driving the compressor.

The capillary tube is quite a simple device and is also not costly. Its pressure equalization property allows the use of a low starting torque motor. The liquid receiver is also eliminated in a capillary tube system because of the need to limit the refrigerant charge. All these factors help to reduce the cost of manufacture of the systems employing a capillary tube as the throttling device.

The capillary tube is used in small hermetic units, such as domestic refrigerators, freezers and room air conditioners.

### **Float Valves**

There are mainly two types of float valves- low side float valves and high side float valve.

#### **Low-side Float Valve**

This is similar to the float valves used for water tanks. In a water tank the float valve is fixed at the outlet of the water supply pipe to the tank. When the water level is low in the tank, the float ball hangs down by its own weight and the float arm keeps the valve fully open to allow water flow into the tank. As the water level rises, the float ball (which is hollow) floats on the water and gradually rises according to the water level, throttling the water through the valve. Ultimately when the tank is full, the float valve completely closes the water supply. As the water from the tank is used, the water level falls down; the float ball also lowers down, opening the valve according to the level of water in the tank.

The low-side float valve also acts in the same way in a refrigeration system. As the name implies the float valve is located in the low pressure side of the system. It is fixed in a chamber (float chamber) which is connected to the evaporator. The valve assembly consists of a hollow

ball, a float arm, needle valve and seat. The needle valve-seat combination provides the throttling effect similar to the expansion valve needle and seat. The movement of the float ball is transmitted to the needle valve by the float arm. The float ball being hollow floats on the liquid refrigerant. The needle valve and seat are located at the inlet of the float chamber. As the liquid refrigerant vaporizes in the evaporator, its level falls down in the chamber. This causes the float ball to drop and pull the needle away from the seat, thereby allowing enough liquid refrigerant to flow into the chamber of the evaporator to make up for the amount of vaporization. When enough liquid enters, the float ball rises and ultimately closes the needle valve when the desired liquid level is reached. The rate of vaporization of liquid and consequent drop in the level of the liquid in the evaporator is dependent on the load. Thus the movement of the float ball and amount of opening of the float valve is according to the load on the evaporator. The float valve responds to liquid level changes only and acts to maintain a constant liquid level in the evaporator under any load without regard for the evaporator pressure and temperature.

Like in the expansion valve, the capacity of the low-side float valve depends on the pressure difference across the orifice as well as the size of the orifice.

Low-side float valves are used for evaporators of the flooded-type system. In bigger capacity plants a small low-side float valve is used to pilot a liquid feed (and throttling) valve. According to the liquid level in the evaporator, the float valve transmits pressure signals to the main liquid feed valve to increase or decrease the extent of its opening. Thus the low-side float valve in such a system is called a 'pilot' and the liquid-feed valve is known as the pilot-operated liquid-feed valve.

### **High-side Float Valve**

The high-side valve like the low-pressure float valve, is a liquid level sensing device and maintains a constant liquid level in the chamber in which it is fixed. However it differs from the low-side float valve in the following respects.

- (d) The high-side float valve and its chamber are located at the high- pressure side of the system, while the low-side float valve is located at the low- pressure side of the system.
- (e) The needle and seat of the valve are at the outlet of the chamber as against the needle valve being at the inlet of the chamber in the low-side float.
- (f) In the high-side float valve, the valve opens on a rise in the liquid level in the chamber, just the opposite action of the low-side float valve, which closes on a rise in liquid level in the chamber.
- (g) The high-side float chamber is located between the condenser and evaporator.  
The liquid condensed in the condenser flows down to the float chamber.

As the liquid level rises in the chamber, the float ball also rises, thereby opening the needle valve. As the liquid level falls in the chamber, the float valve tends to close the seat orifice. It is obvious that refrigerant vapour is condensed in the condenser at the same rate at which the liquid vaporizes in the evaporator; the float chamber receives and feeds liquid to the evaporator at the same rate. Since the rate of vaporization of the liquid in the evaporator is according to the load, the high-side float obviously works as per the load.

This type of float valve is generally used in centrifugal-refrigeration plants.

Refrigerant feed/throttling devices for flooded chillers are usually the low- side or high-side float valve. For example, in centrifugal plants, the chiller is of the flooded type and generally high-side float valves are used as throttling devices. In a flooded chiller working in conjunction with a reciprocating compressor, a low-side float valve is used as the throttling and refrigerant liquid flow control.

### **Thermo - static Expansion Valve**

The name ‘thermostatic-expansion valve’ may give the impression that it is a temperature control device. It is not a temperature control device and it cannot be adjusted and used to vary evaporator temperature. Actually TEV is a throttling device which works automatically, maintaining proper and correct liquid flow as per the dictates of the load on the evaporator. Because of its adaptability to any type of dry expansion application, automatic operation, high efficiency and ability to prevent liquid flood backs, this valve is extensively used.

The functions of the thermostatic-expansion valve are:

- (h) To reduce the pressure of the liquid from the condenser pressure to evaporator pressure,
- (i) To keep the evaporator fully active and
- (j) To modulate the flow of liquid to the evaporator according to the load requirements of the evaporator so as to prevent flood back of liquid refrigerant to the compressor.

It does the last two functions by maintaining a constant superheat of the refrigerant at the outlet of the evaporator. It would be more appropriate to call it a ‘constant superheat valve’.

The important parts of the valve are:

Power element with a feeler bulb, valve seat and needle, and a superheat adjustment spring.

Refrigeration systems refer to the different physical components that make up the total refrigeration unit. The different stages in the refrigeration cycle are undergone in these physical systems. These systems consist of an evaporator, a condenser, a compressor and an expansion valve.

The evaporator is the space that needs to be cooled by the refrigerant; the compressor compresses the refrigerant from the low pressure of the evaporator to the pressure at the condenser. The heat gained by the refrigerant is rejected at the condenser and the high pressure refrigerant is expanded into the low pressure evaporator by the expansion valve. This is a very general representation of the various units in a refrigeration system.

The refrigeration systems vary according to the purpose and the type of refrigerant used. They are the means by which we can actually carry out the refrigeration process. A better understanding of them is thus, very essential.

**UNIT III**  
**VAPOUR ABSORPTION REFRIGERATION AND**  
**AIR REFREGIRATION**

## **VAPOUR ABSORPTION SYSTEM**

The vapour absorption refrigeration is heat operated system. It is quite similar to the vapour compression system.

## **VAPOUR COMPRESSION SYSTEMS**

The challenge in refrigeration and air conditioning is to remove heat from a low temperature source and dump it at a higher temperature sink. Compression refrigeration cycles in general take advantage of the idea that highly compressed fluids at one temperature will tend to get colder when they are allowed to expand. If the pressure change is high enough, then the compressed gas will be hotter than our source of cooling (outside air, for instance) and the expanded gas will be cooler than our desired cold temperature. In this case, we can use it to cool at a low temperature and reject the heat to a high temperature.

Vapour-compression refrigeration cycles specifically have two additional advantages. First, they exploit the large thermal energy required to change a liquid to a vapour so we can remove lots of heat out of our air-conditioned space. Second, the isothermal nature of the vaporization allows extraction of heat without raising the temperature of the working fluid to the temperature of whatever is being cooled. This is a benefit because the closer the working fluid temperature approaches that of the surroundings, the lower the rate of heat transfer. The isothermal process allows the fastest rate of heat transfer

Vapour compression refrigeration is the primary method to provide mechanical cooling. All vapor compression systems consist of the following four basic components alongwith the interconnecting piping. These are the evaporator, condenser, compressor and the expansion valve. Typical vapor compression systems can be represented as shown in figure

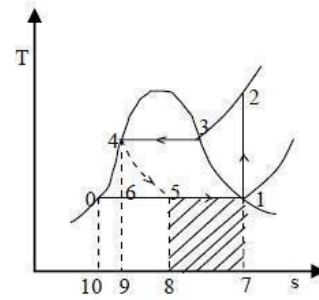
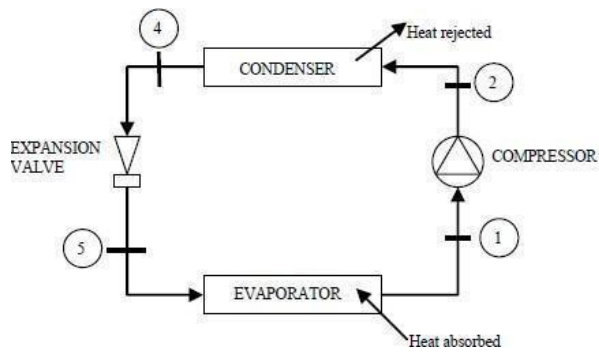

### Schematic Representation of a Vapour Compression System and T-S Diagram

The evaporator and the condenser are heat exchangers that evaporate and condense the refrigerant while absorbing and rejecting the heat. The compressor takes the refrigerant from the evaporator and raises the pressure sufficiently for the vapor to condense in the condenser. The expansion device controls the flow of condensed refrigerant at this higher pressure back into the evaporator. Some typical expansion devices are throttle valves, capillary tubes and thermostatic expansion valves in case of large refrigeration systems.

Figure shows the  $T$ - $S$  plot of the working of such a system. Here, the dry saturated working medium at state 1 is compressed isentropically to state 2.

Constant pressure heat transfer occurs from state 2 until the compressed vapor becomes saturated liquid or condensate at state 4. The compressed vapor is next throttled from the high pressure region in the condenser (state 4) to the low pressure region in the evaporator (state 5). Since throttling is an irreversible process, it is represented by a broken line. After throttling to evaporator pressure, the heat transfer in the evaporator causes vaporization of the working medium until state 1 is reached, thus completing the cycle. The process 4-5 is assumed to be adiabatic during throttling, an isenthalpic process.



## CARNOT VAPOR COMPRESSION SYSTEMS

Here, the compression is imagined to take place in two stages: isentropic compression upto state 2 and isothermal compression from state 2 to 3 as shown in Figure

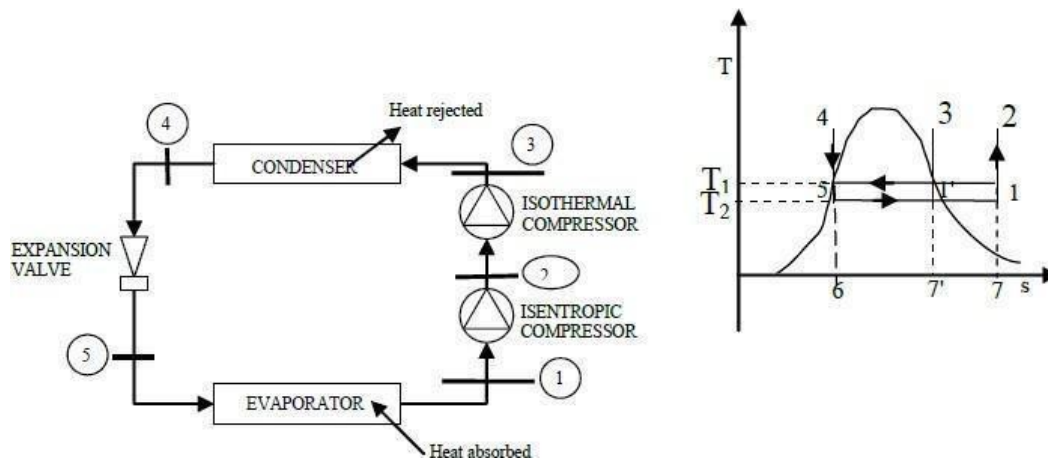

### Schematic Representation of a Carnot Vapour Compression System and T-S Diagram

The working medium is condensed in a heat exchanger giving saturated liquid at state 4. The isentropic expansion from state 4 to state 5 gives the refrigeration effect, the area under line 5-1.

Comparing figs, we can see that the Carnot vapor compression cycle gives a greater refrigeration effect than the vapor compression cycle. It can be seen that the refrigeration system working on the Carnot vapor compression cycle has the highest COP.

### LIMITATIONS OF CARNOT VAPOR COMPRESSION SYSTEMS WITH VAPOR AS REFRIGERANT

Although in theory, the Carnot vapor compression cycle has the highest COP; it is not suited for use in practical refrigeration systems. This is because it is virtually impossible to compress the refrigerant isothermally from state 2 to state 3 in a finite time interval. To offset this

difficulty, we can follow the alternate path 1'-3-4-5. However, this results in other difficulties which are mentioned in detail below:

### **Dry vs. Wet Compression**

If the Carnot vapour cycle follows the path 1-2-3-4, then there is dry compression of the refrigeration vapor since the refrigerant is dry saturated at state 1. This type

of compression is desirable in the compressor. But, in this case we see that the refrigerant now has to be compressed isothermally from state 2 to state 3, which is impossible to achieve in practice. The alternate path 1'-3-4-5 involves a wet compression of the vapor from state 1' to state 3. Wet compression is highly undesirable as the compressor now has to deal with two different fluid phases. Besides, the liquid droplets present in the vapor would now react with the lubricant in the compressor which is highly undesirable. Thus, we see that both the paths of the Carnot vapor cycle are not suitable for use in practical refrigeration systems.

### **Throttling vs. Isentropic Compression**

In the Carnot vapour compression cycle, there is isentropic expansion from state 4 to state 5. This is achieved by the use of a turbine. However, in actual cycles, the expansion from saturated liquid at state 4 to liquid-vapor mixture at state 5 produces very little work. A turbine working under such conditions would have very low efficiency which would not justify the cost involved in using a turbine. Also, the refrigeration system would become very bulky and not suitable for domestic use.

In actual practice, an expansion valve is used to achieve the desired expansion from state 4 to state 5. The refrigerant gets throttled in the expansion valve from saturated liquid to liquid-vapor mixture. The expansion no longer remains isentropic. The expansion now becomes an isenthalpic process.

Thus, we see that the Carnot vapour refrigeration cycle is not suitable for use in refrigeration systems. A better ideal cycle is the vapor compression refrigeration cycle.

### **VAPOUR ABSORPTION SYSTEMS**

In both the systems, there are evaporator and condenser. The process of evaporation and condensation of the refrigerant takes place at two different pressure levels to achieve refrigeration in both the cases. The method employed to create the two pressure levels in the system for evaporation and condensation of the refrigeration makes the two processes different. Circulation of refrigerant in both the cases is also different.

In the absorption system the compressor of the vapour compression system is replaced by the combination of „absorber“ and „generator“. A solution known as the absorbent, which has an affinity for the refrigerant used, is circulated between the absorber and the generator by a pump (solution pump). The absorbent in the absorber draws (or sucks) the refrigerant vapour formed in the evaporator thus maintaining a low pressure in the evaporator to enable the refrigerant to evaporate at low temperature. In the generator the absorbent is heated. There by releasing the refrigerant vapour (absorbed in the absorber) as high pressure vapour, to be condensed in the condenser. Thus the suction function is performed by absorbent in the absorber and the generator performs the function of the compression and discharge. The absorbent solution carries the refrigerant vapour from the low side (evaporator-absorber) to the high side (generator-condenser). The liquefied refrigerant flows from the condenser to the evaporator due to the pressure difference between the two vessels; thus establishing circulation of the refrigerant through the system.

The absorbent solution passing from the generator to the absorber is hot and has to be cooled. On the other hand the absorbent solution sent to the generator is cooled and has to be heated in

the generator for the regeneration of the refrigerant. A shell and tube heat exchanger is introduced between the generator and the absorber.

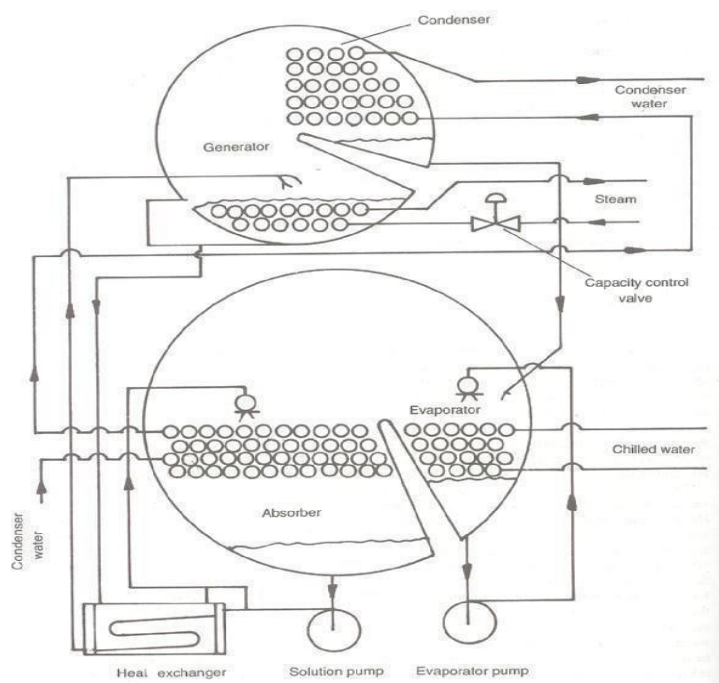
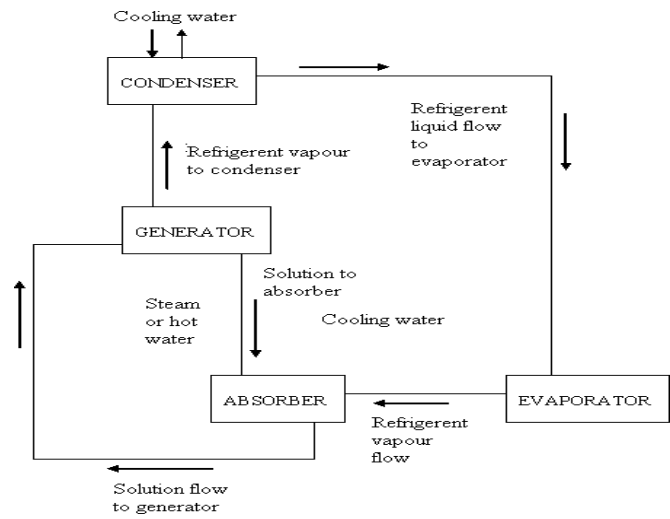

**Schematic Diagram of Absorption System of Refrigeration**

**Schematic Sketch of a Lithium-Bromide Absorption Machine – Single Stage**

There is number of vapour absorption system depending on the absorbent e.g. ammonia absorbent system, lithium bromide absorption system etc. Ammonia absorbent systems were used in the early stages of refrigeration. This system uses ammonia as the refrigerant and water

as absorbent. In lithium bromide absorption system lithium bromide salt solution absorbent and water as the refrigerant. A concentrated solution of lithium bromide has a great affinity for water. Since water is the refrigerant, the refrigerant operating temperature in the evaporator has to be above the freezing point of water ( $0^{\circ}\text{C}$ ) of water

## **AIR REFRIGERATION**

### **INTRODUCTION**

The art of air conditioning developed only gradually from the predecessor arts of cooling, cleaning, heating and ventilating. Towards the latter half of the 19<sup>th</sup> century, the developments in the art of humidifying air went along with the progress of textile industry in England. It is worth mentioning here the name of

Wolff who designed air-conditioning systems for as many as hundred buildings during his life-time. But it is W.H.Carrier (1876-1950) who is known as the „Father of Air Conditioning“. He engineered and installed the first year-round air-conditioning system, providing for the four major functions of heating, cooling, humidifying and dehumidifying. He made use of air washers for controlling the dew point of air by heating or chilling recirculated water. Carrier presented his remarkable paper „Rational Psychrometric Formulae“ in an ASME meeting. Carrier also employed the centrifugal compressor for refrigeration in 1922. As far as air conditioning for comfort is concerned, it got off the ground in motion-picture theatres in 1920 in Chicago employing CO<sub>2</sub> machines and in 1922 in Los Angeles employing NH<sub>3</sub> compressors.

In the following chapters, attention will henceforth be focused on the art and science of air conditioning which is the greatest single application of refrigeration, in addition to that of heating and ventilation. For this purpose it is necessary to study the properties of the working substances in air conditioning, viz ., moist air.

## WORKING SUBSTANCE IN AIR CONDITIONING

An important thing for the student of air conditioning is to appreciate that the working substance under study, viz., moist air, is a mixture of two gases. One of these is dry air which itself is a mixture of a number of gases and the other is water vapour which may exist in a saturated or superheated state.

One might ask whether moist air can be considered as a pure substance. But a pure substance is *homogeneous* and *invariable* in *chemical composition*. Thus, a homogeneous mixture of gases is a pure substance until its components do not change in phase. Dry air is a good example of such a kind of pure substance.

Water vapour is certainly a pure substance. But moist air is not a pure substance in any process in which condensation or evaporation of moisture occurs. In such a case, regular charts have to be developed to describe the thermodynamic properties of the mixture under different conditions and compositions.

It is, thus, seen that moist air consists of two parts: one, comprising dry air, considered as the fixed part, and the other, solely of water vapour, considered as the variable part.

The dry air part is a mixture of a number of permanent gases with approximate compositions as given in Table 6.1.

Both dry air and water vapour can be considered as perfect gases since both exist in the atmosphere at low pressures. Hence, perfect gas laws can be applied to them individually. In addition, Gibbs-Dalton laws for non-reactive mixtures of gases can be applied to the dry air part only to obtain its properties as a single pure substance, before establishing the properties of moist air.

**UNIT IV**

**INTRODUCTION TO AIR CONDITIONING**

## PSYCHROMETRIC PROPERTIES

The properties of moist air are called *psychrometric properties* and the subject which deals with the behaviour of moist air is known as *psychrometry*.

*Moist air* is a mixture of dry air and water vapour. They form a binary mixture. A mixture of two substances requires three properties to completely define its thermodynamic state, unlike a pure substance which requires only two. One of the three properties can be the composition. Water vapour is present in the atmosphere at a very low partial pressure. At this low pressure and atmospheric temperature, the water vapour behaves as a perfect gas. The partial pressure of dry air is also below one atmosphere which may also be considered to behave very much as a perfect gas. The Gibbs-Dalton laws of perfect gas mixture can be applied to the moist air.

Since the water vapour part is continuously variable, all calculations in air-conditioning practice are based on the dry air part.

For calculating and defining the psychrometric properties, we may consider a certain volume  $V$  of moist air at pressure  $p$  and temperature  $T$ , containing  $m_a$  kg of dry air and  $m_v$  kg of water vapour as shown in Figure 6.3. The actual temperature  $t$  of moist air is called the *dry bulb temperature* (DBT).

The total pressure  $p$  which is equal to the *barometric pressure* is constant.

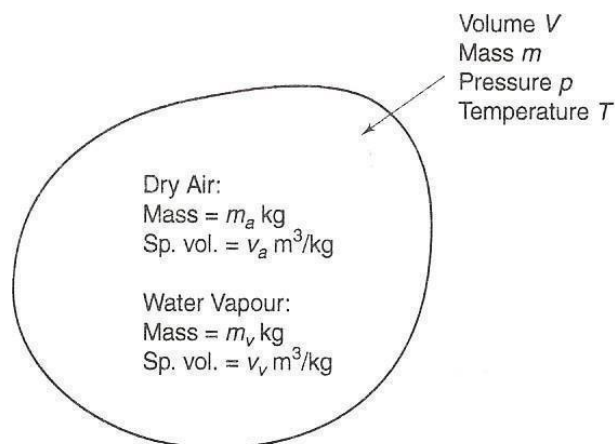



### Specific Humidity or Humidity Ratio

*Specific or absolute humidity or humidity ratio or moisture content* is defined as the ratio of the mass of water vapour to the mass of dry air in a given volume of the mixture. It is denoted by the symbol  $\omega$ .

$$\omega = \frac{m_v}{m_a} = \frac{V/v_v}{V/v_a} = \frac{v_a}{v_v} \qquad \omega = 0.622 \frac{P_v}{p - P_v}$$

### Dew Point Temperature

The normal thermodynamic state 1 as shown in the Figure 6.4 (a) of moist air is considered as *unsaturated air*. The water vapour existing at temperature  $T$  of the mixture and partial pressure  $p_v$  of the vapour in the mixture is normally in a superheated state.

If a sample of such unsaturated moist air containing superheated water vapour is cooled (at constant pressure), the mixture will eventually reach the saturation temperature  $t_d$  of water vapour corresponding to its partial pressure  $p_v$ , at which point the first drop of dew will be formed, i.e., the water vapour in the mixture will start condensing. This temperature  $t_d$  is called the *dew point temperature* (DPT).

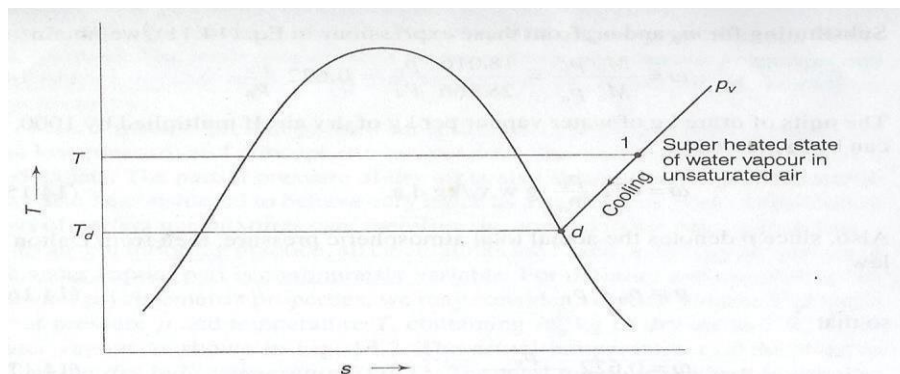

## Thermodynamic State of Water Vapour in Moist Air

Moisture can be removed from humid air by bringing the air in contact with a *cold surface* or *cooling coil* whose temperature is below its dew point temperature. During the process of cooling, the partial pressure  $p_v$  of water vapour and specific humidity  $\omega$  remain constant until the vapour starts condensing.

## Degree of Saturation

Consider the water vapour in the super heated thermodynamic state 1 in unsaturated moist air representing the control volume  $V$ . the water vapour exists at the dry bulb temperature  $T$  of the mixture and partial pressure  $p_v$  as shown in the Figure 6.4 (b).

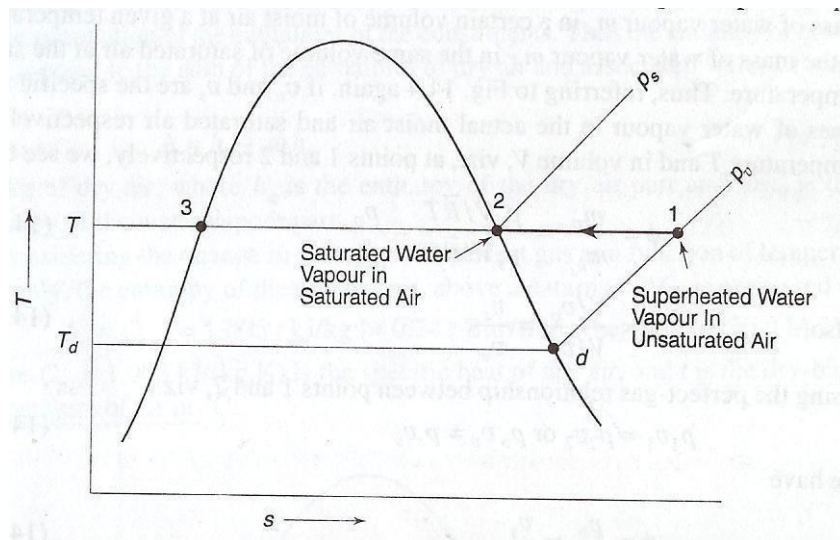

## An Imaginary Isothermal Process Showing the Change of State of Water Vapour

Now consider that more water vapour is added in this control volume  $V$  at temperature  $T$  itself. The partial pressure  $p_v$  will go on increasing with the addition of water vapour until it reaches a value  $p_s$  corresponding to state 2 in Figure 6.4 after which it cannot increase further as  $p_s$  is the saturation pressure or maximum possible of water at temperature  $T$ . the thermodynamic state of water vapour is now saturated at point 2. the air containing moisture in such a state is called *saturated air*. In this state the air is holding the maximum amount of water vapour( the

specific humidity being  $\omega_s$ , corresponding to the partial pressure  $p_s$ ) at temperature  $T$  of the mixture. The maximum possible specific humidity,  $\omega_s$  at temperature  $T$  is thus

$$\omega_s = 0.622 \frac{P_s}{p - P_s}$$

The ratio of the actual specific humidity  $\omega$  to the specific humidity  $\omega_s$  of saturated air at temperature  $T$  is termed as the *degree of saturation* denoted by the symbol  $\mu$ . Thus

$$\mu = \frac{\omega}{\omega_s} = \frac{p_v}{p_s} \left[ \frac{1 - p_s/p}{1 - p_v/p} \right]$$

Thus the degree of saturation is a measure of the capacity of air to absorb moisture.

### Relative Humidity

The relative humidity  $\phi$  is defined as the ratio of the mole fraction of water vapour in moist air to mole fraction of water vapour in saturated air at the same temperature and pressure. From perfect-gas relationships another expression for  $\phi$

$$\phi = \frac{\text{existing partial pressure of water vapor}}{\text{saturation pressure of pure water at same temperature}}$$

$$\phi = \frac{m_v}{m_{v_s}} = \frac{p_v v / RT}{p_s v / RT} = \frac{p_v}{p_s}$$

$$\phi = \frac{V/v_v}{V/v_s} = \frac{v_s}{v_v}$$

$$\omega = 0.622 \phi \frac{p_s}{p_a}$$

$$\phi = \frac{\omega p_a}{0.622 p_s}$$

Also we may write

$$\mu = \phi \left[ \frac{1 - p_s/p}{1 - p_v/p} \right]$$

$$\phi = \frac{\mu}{1 - (1 - \mu) p_s/p}$$

## Enthalpy of Moist Air

According to Gibb's law, the enthalpy of a mixture of perfect gases can be obtained by the net summation of the enthalpies of the respective constituents. Therefore the enthalpy of the moist air  $h$  is equal to the summation of the enthalpies of dry air and of the water vapour associated with the air.

Hence,

$$h = h_a + w h_v$$

Per kg of dry air, where  $h_a$  is the enthalpy of the dry air part and  $w h_v$  is the enthalpy of the water vapour part. The change in enthalpy of a perfect gas being considered as a function of temperature only, the enthalpy of the dry air part above a datum of  $0^\circ\text{C}$  is expressed as:

$$h_a = C_{pa} t = 1.005 t \text{ kJ/kg} (= 0.24 t \text{ Btu/lbm where } t \text{ is in } ^\circ\text{F})$$

where  $C_p = 1.005 \text{ kJ/kg.K}$  is the specific heat of dry air, and  $t$  is the dry-bulb temperature of air in  $^\circ\text{C}$ .

Assuming the reference state enthalpy as zero for saturated liquid at  $0^\circ\text{C}$ , the enthalpy of water vapour at point A in the above Figure can be expressed as:

$$h_v = h_A = C_{pw} t_d + (h_{fg})_d + C_{pv} (t - t_d) \text{ kJ/kg where } C_{pw} = \text{specific heat of liquid water}$$

$t_d$  = dew point temperature

$(h_{fg})_d$  = latent heat of vaporization at DPT

$C_{pv}$  = specific heat of superheated vapour

Taking the specific heat of liquid water as  $4.1868 \text{ kJ/kg K}$  and that of water vapour as  $1.88 \text{ kJ/kg K}$ , in the range  $0$  to  $60^\circ\text{C}$ , we have

$$h_v = 4.1868 t_d + (h_{fg})_d + 1.88 (t - t_d)$$

At low pressure for an ideal gas, the enthalpy is a function of temperature only. Thus in Figure 6.5 the enthalpies at point B and C are also the same as the enthalpy at A. Accordingly, enthalpy of water vapour at A, at DPT of  $t_d$  and DBT of  $t$ , can be determined more conveniently by the following two methods:

- (a)  $h_A = h_C = (h_g)_t$
- (b)  $h_A = h_B = (h)_{0^\circ C} + C_{pv}(t - 0)$   
fg  $0^\circ C$

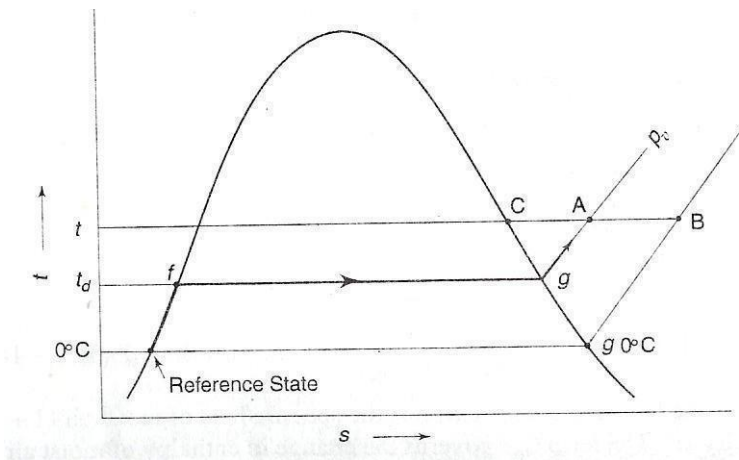

### Evaluation of Enthalpy of Water Vapour Part

Using second expression and taking the latent heat of vaporization of water at  $0^\circ C$  as  $2501\text{ kJ/kg}$ , we obtain the empirical expression for the enthalpy of the water vapour part

$$h_v = 2501 + 1.88t\text{ kJ/kg}$$

And combining, we have the enthalpy of moist air

$$h = 1.005t + \omega(2500 + 1.88t)\text{ kJ/kg d.a}$$

### HUMID SPECIFIC HEAT

The enthalpy of moist air can also be written as

$$h = (C_{pa} + \omega C_{pv})t + \omega(h_{fg})_{0^\circ C}$$

$$= C_p t + \omega(h_{fg})_{0^\circ C}$$

where  $C_p = C_{pa} + \omega C_{pv}$

$$= (1.005 + 1.88\omega)\text{ kJ/(kg d.a.) (K)}$$

It is the specific heat of moist air  $(1 + \omega)$  kg per kg of dry air.

### **WET BULB TEMPERATURE (WBT)**

A psychrometer comprises of a dry bulb thermometer and a wet bulb thermometer. The dry bulb thermometer is directly exposed to the air and measures the actual temperature of air and is called dry bulb temperature. When the thermometer bulb is surrounded by a wet cloth exposed to the air. The temperature which is measured by the wick-covered bulb of such a thermometer indicates the temperature of liquid water in the wick and is called the *wet bulb temperature*. It is denoted by the symbol  $t'$ .

The difference between the dry bulb and wet bulb temperatures is called *wet bulb depression* (WBD).

$$\text{WBD} = (t - t')$$

If the ambient air is saturated, i.e. the RH is 100 per cent, then there will be no evaporation of water on the bulb and hence WBT and DBT will be equal. The WBT is an indirect measure of the dryness of air.

### **ADIABATIC SATURATION AND THERMODYNAMIC WET BULB TEMPERATURE**

The thermodynamic wet bulb temperature or adiabatic saturation temperature is the temperature at which the air can be brought to saturation state, adiabatically, by the evaporation of water into the flowing air.

The equipment used for the adiabatic saturation of air, in its simplest form, consists of an insulated chamber containing adequate quantity of water. There is also an arrangement for extra water (known as make-up water) to flow into the chamber from its top, as shown in Figure

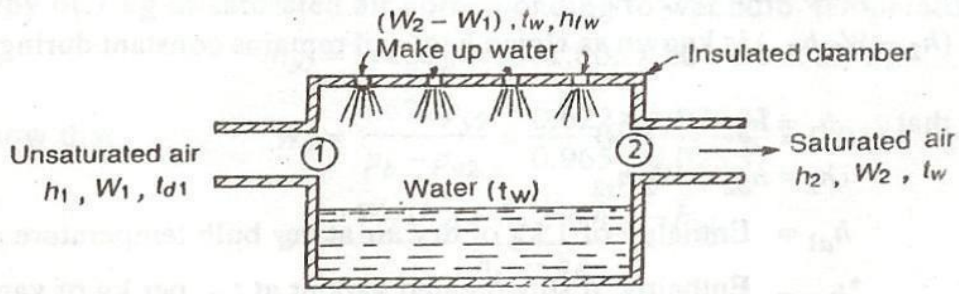

### Adiabatic Saturation of Air

Let the unsaturated air enters the chamber at section 1. As the air passes through the chamber over a long sheet of water, the water evaporates which is carried with the flowing stream of air, and the specific humidity of the air increases. The make up water is added to the chamber at this temperature to make the water level constant. Both the air and water are cooled as the evaporation takes place. This process continues until the energy transferred from the air to the water is equal to the energy required to vaporise the water. When steady conditions are reached, the air flowing at section 2 is saturated with water vapour. The temperature of the saturated air at section 2 is known as *thermodynamic wet bulb temperature or adiabatic saturation temperature*.

The adiabatic saturation process can be represented on T-s diagram as shown by the curve 1-2 in Figure 6.7.

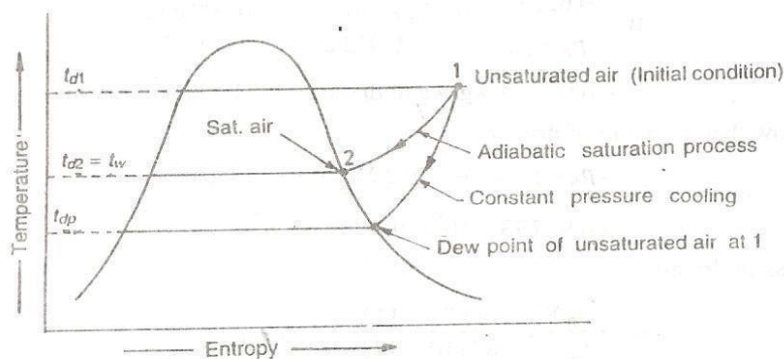

**T-S Diagram for Adiabatic Saturation Process**

During the adiabatic saturation process, the partial pressure of vapour increases, although the total pressure of the air-vapour mixture remains constant. The unsaturated air initially at dry bulb temperature  $t_{d1}$  is cooled adiabatically to dry bulb temperature  $t_{d2}$  which is equal to the adiabatic saturation temperature  $t_w$ . It may be noted that the adiabatic saturation temperature is taken equal to the wet bulb temperature for all practical purposes.

Let  $h_1$  = Enthalpy of unsaturated air at section 1,  $W_1$  = Specific humidity of air at section 1,  $h_2$ ,

$W_2$  = Corresponding values of saturated air at section 2, and

$h_{fw}$  = Sensible heat of water at adiabatic saturation temperature. Balancing the

enthalpies of air at inlet and outlet (i.e. at sections 1 and 2),  $h_1 + (W_2 - W_1)$

$$h_{fw} = h_2$$

$$h_1 - W_1 h_{fw} = h_2 - W_2 h_{fw}$$

The term  $(h_2 - W_2 h_{fw})$  is known as sigma heat and remains constant during the adiabatic process

We know that  $h_1 = h_{a1} + W_1 h_{s1}$

$$h_2 = h_{a2} + W_2 h_{s2}$$

where

$h_{a1}$  = Enthalpy of 1 kg of dry air at dry bulb temperature  $t_{d1}$ ,

$h_{s1}$  = Enthalpy of superheated vapour at  $t$  per kg of vapour,

$h_{a2}$  = Enthalpy of 1 kg of air at wet bulb temperature  $t_w$ , and

$h_{s2}$  = Enthalpy of saturated vapour at wet bulb temperature  $t_w$  per kg of vapour.

Now the equation may be written as:



$$(h_{a1} + W_1 h_{s1}) - W_1 h_{fw} = (h_{a2} + W_2 h_{s2}) - W_2 h_{s2}$$

$$W_1(h_{s1} - h_{fw}) = W_2(h_{s2} - h_{fw}) + h_{a2} - h_{a1}$$

$$W_1 = \frac{W_2(h_{s2} - h_{fw}) + h_{a2} - h_{a1}}{h_{s1} - h_{fw}}$$

## PSYCHROMETRIC CHART

All data essential for the complete thermodynamic and psychrometric analysis of air-conditioning processes can be summarised in a psychrometric chart. At present, many forms of psychrometric charts are in use. The chart which is most commonly used is the  $\omega$ - $t$  chart, i.e. a chart which has specific humidity or water vapour pressure along the ordinate and the dry bulb temperature along the abscissa. The chart is normally constructed for a standard atmospheric pressure of 760 mm Hg or 1.01325 bar, corresponding to the pressure at the mean sea level. A typical layout of this chart is shown in Figure

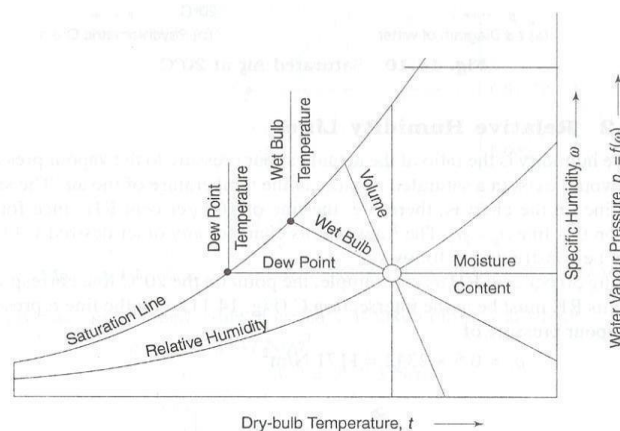

### Constant Property Lines on a Psychrometric Chart

#### Saturation Line

The saturation line represents the states of saturated air at different temperatures. As an example of fixing such a state on the chart, consider an atmosphere A at 20 °C and saturation as shown in Figure 6.9. From the steam tables at 20 °C, water vapour pressure

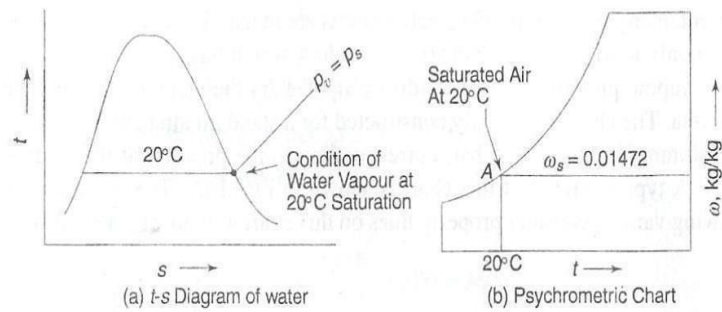

### Saturated Air at 20 °C

$p_s = p_v = 17.54 \text{ mm Hg} = 2342 \text{ N/m}^2$  Partial pressure of dry air  $p_a = p -$

$p_v = 101325 - 2342 = 98983 \text{ N/m}^2$

Specific humidity at 20 °C saturation

$$\omega_s = \frac{0.622 p_v}{P_a} = \frac{0.622(2342)}{98983} = 0.01472 \text{ kg w.v./kg d.a.}$$

Knowing  $t$  and  $\omega$ , point a can be plotted. In a similar manner, saturation states at other temperatures can also be plotted to draw the saturation line on the psychrometric chart.

### Relative Humidity Lines

The relative humidity  $\phi$  is defined as the ratio of the mole fraction of water vapour in moist air to mole fraction of water vapour in saturated air at the same temperature and pressure. From perfect-gas relationships another expression is

$$\phi = \frac{\text{existing partial pressure of water vapor}}{\text{saturation pressure of pure water at same temperature}}$$

The relative humidity lines are curved lines and follow the saturation curve.

Generally, these lines are drawn with values 10%, 20%, 30% etc. and up to 100%. The saturation curve represents 100% relative humidity. The values of relative humidity lines are generally given along the lines themselves as shown in Figure

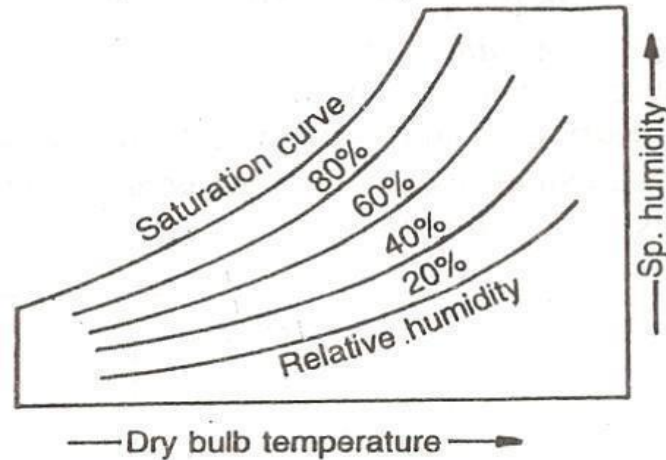

### Relative Humidity Lines

The lines on psychrometric chart for any other desired value of RH can be constructed as follows. Taking 50 per cent RH as an example, the point on the 20°C line corresponding to this RH must be at the intersection C (Figure) with the line representing a vapour pressure of

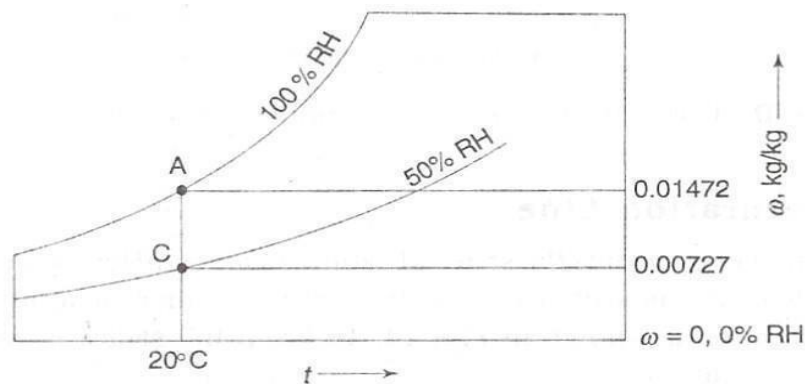

### Constant Specific Volume Lines

The constant specific volumes lines are obliquely inclined straight lines and uniformly spaced as shown in Figure. These lines are drawn up to the saturation curve. To establish points on a

line of constant specific volume,  $0.90 \text{ m}^3/\text{kg}$  for example, From the perfect-gas equation, the specific volume  $v$  is substitute  $0.90$  for  $v$ , the barometric pressure for  $p_t$ , and at arbitrary values of  $T$  solve for  $p_s$ . the pairs of  $p_s$  and  $t$  values then describe the line of constant  $v$ .

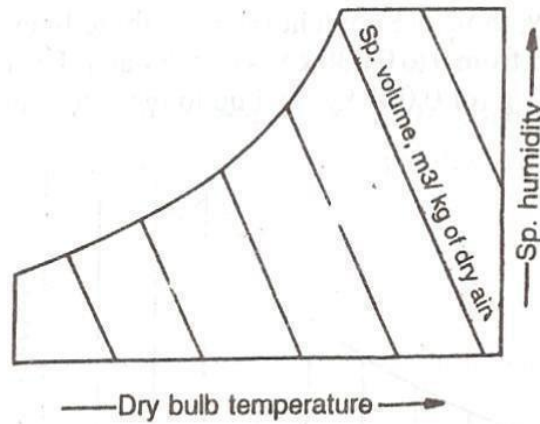

**Specific Volume Lines**

$$v = \frac{R_a T}{P_a} = \frac{R_a T}{P_t - P_s} \quad \text{m}^3/\text{kg dry air}$$

**Constant Thermodynamic Wet Bulb Temperature Lines**

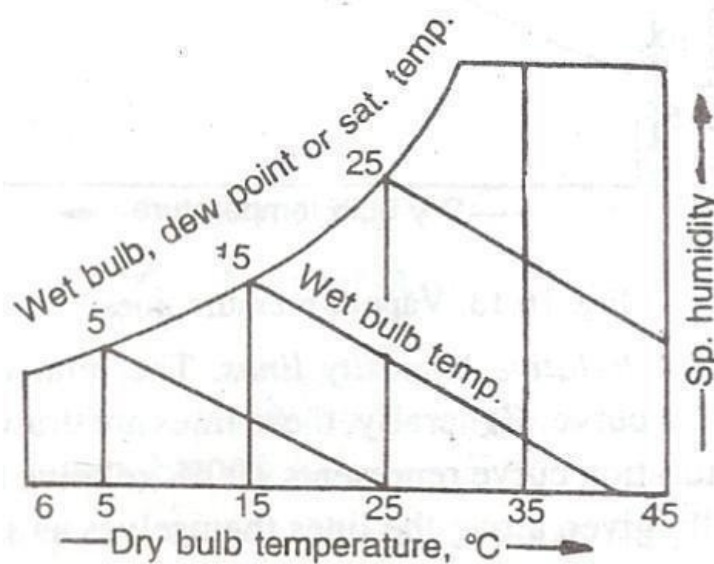

**Wet Bulb Temperature Lines**

The wet bulb temperature lines are inclined straight lines and non-uniformly spaced as shown in Figure 6.13 any point on the saturation curve, the dry bulb and wet bulb temperatures are equal.

The values of wet bulb temperatures are generally given along the saturation curve of the chart as shown in the Figure.

### Constant Enthalpy Lines

The enthalpy (or total heat) lines are inclined straight lines and uniformly spaced as shown in Figure 16.14. These lines are parallel to the wet bulb temperature lines, and are drawn up to the saturation curve. Some of these lines coincide with the wet bulb temperature lines also.

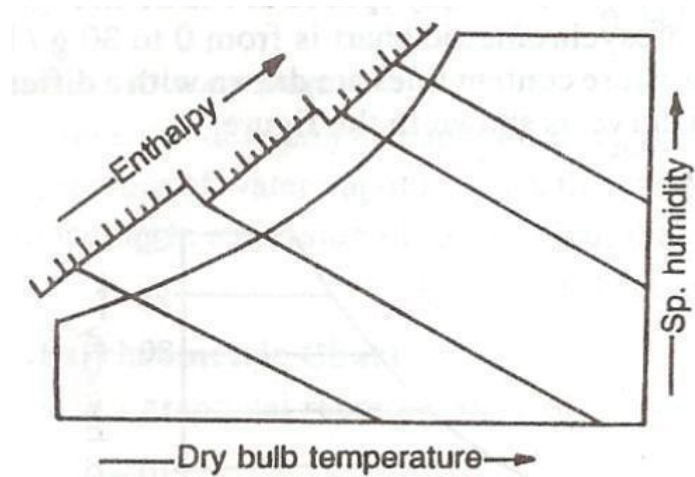

Constant Enthalpy Lines

**UNIT V**  
**AIR CONDITIONING SYSTEMS**

## AIR CONDITIONING SYSTEMS

### Introduction:

In order to maintain required conditions inside the conditioned space, energy has to be either supplied or extracted from the conditioned space. The energy in the form of sensible as well as latent heat has to be supplied to the space in winter and extracted from the conditioned space in case of summer. An air conditioning system consists of an air conditioning plant and a thermal distribution system as shown in Fig. 36.1. As shown in the figure, the air conditioning (A/C) plant acts either as a heat source (in case of winter systems) or as a heat sink (in case of summer systems). Air, water or refrigerant are used as media for transferring energy from the air conditioning plant to the conditioned space. A thermal distribution system is required to circulate the media between the conditioned space and the A/C plant. Another important function of the thermal distribution system is to introduce the required amount of fresh air into the conditioned space so that the required Indoor Air Quality (IAQ) can be maintained.

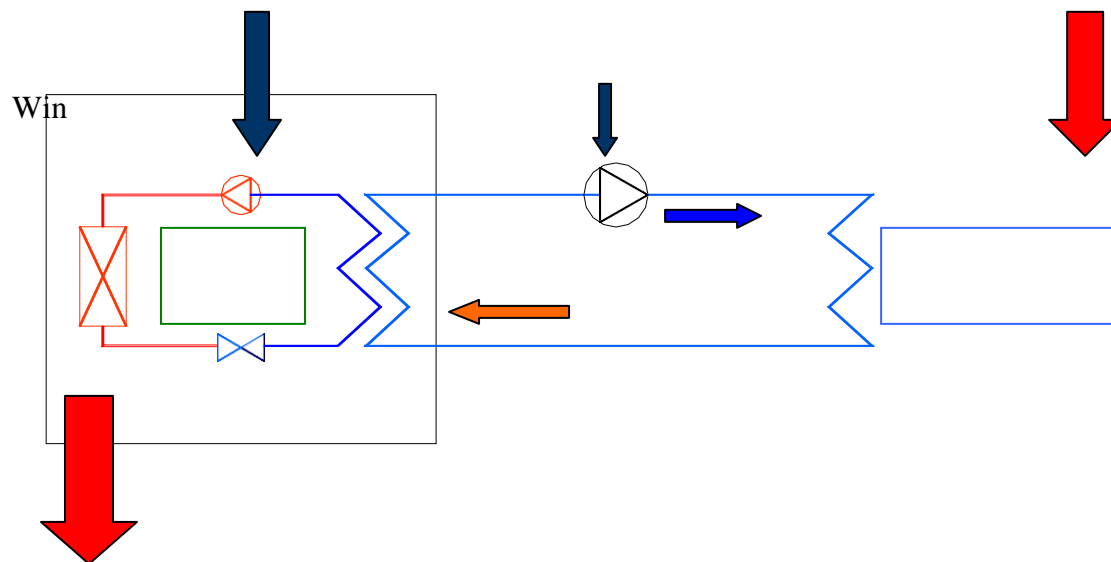

*Schematic of a summer air conditioning system with the thermal distribution system*

### Selection criteria for air conditioning systems:

Selection of a suitable air conditioning system depends on:

1. Capacity, performance and spatial requirements
2. Initial and running costs
3. Required system reliability and flexibility
4. Maintainability
5. Architectural constraints

The relative importance of the above factors varies from building owner to owner and may vary from project to project. The typical space requirement for large air conditioning systems may vary from about 4 percent to about 9 percent of the gross building area, depending upon the type of the system. Normally based on the selection criteria, the choice is narrowed down to 2 to 3 systems, out of which one will be selected finally.

Classification of air conditioning systems:

Based on the fluid media used in the thermal distribution system, air conditioning systems can be classified as:

1. All air systems
2. All water systems
3. Air- water systems
4. Unitary refrigerant based systems

**All air systems:**

As the name implies, in an all air system air is used as the media that transports energy from the conditioned space to the A/C plant. In these systems air is processed in the A/C plant and this processed air is then conveyed to the conditioned space through insulated ducts using blowers and fans. This air extracts (or supplies in case of winter) the required amount of



sensible and latent heat from the conditioned space. The return air from the conditioned space is conveyed back to the plant, where it again undergoes the required processing thus completing the cycle. No additional processing of air is required in the conditioned space. All air systems can be further classified into:

1. Single duct systems, or
2. Dual duct systems

The single duct systems can provide either cooling or heating using the same duct, but not both heating and cooling simultaneously. These systems can be further classified into:

1. Constant volume, single zone systems
2. Constant volume, multiple zone systems
3. Variable volume systems

The dual duct systems can provide both cooling and heating simultaneously. These systems can be further classified into:

1. Dual duct, constant volume systems
2. Dual duct variable volume systems

**Single duct, constant volume, single zone systems:**

Figure shows the classic, single duct, single zone, constant volume systems. As shown in the figure, outdoor air (OD air) for ventilation and recirculated air (RC air) are mixed in the required proportions using the dampers and the mixed air is made to flow through a cooling and dehumidifying coil, a heating coil and a humidifier using a an insulated ducting and a supply fan. As the air flows through these coils the temperature and moisture content of the air are brought to the required values. Then this air is supplied to the conditioned space,

where it meets the building cooling or heating requirements. The return air leaves the conditioned space, a part of it is recirculated and the remaining part is vented to the atmosphere. A thermostat senses the temperature of air in the conditioned space and controls the amount of cooling or heating provided in the coils so that the supply air temperature can be controlled as per requirement. A humidistat measures the humidity ratio in the conditioned space and controls the amount of water vapour added in the humidifier and hence the supply air humidity ratio as per requirement.

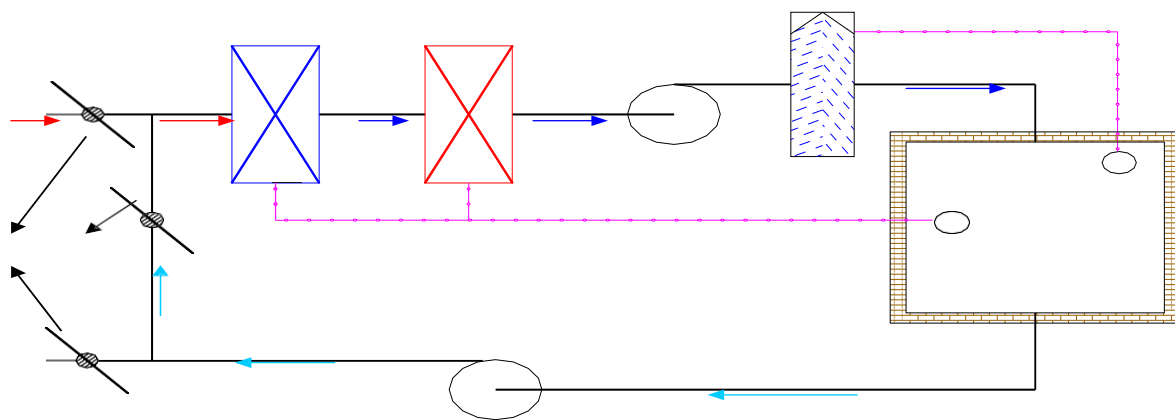

This system is called as a single duct system as there is only one supply duct, through which either hot air or cold air flows, but not both simultaneously. It is called as a constant volume system as the volumetric flow rate of supply air is always maintained constant. It is a single zone system as the control is based on temperature and humidity ratio measured at a single point. Here a zone refers to a space controlled by one thermostat. However, the single zone may consist of a single room or one floor or whole of a building consisting of several rooms. The cooling/ heating capacity in the single zone, constant volume systems is regulated by regulating the supply air temperature and humidity ratio, while keeping the supply airflow rate constant. A separate sub-system controls the amount of OD air supplied by controlling the damper position.

Since a single zone system is controlled by a single thermostat and humidistat, it is important to locate these sensors in a proper location, so that they are indicative of zone conditions. The supply air conditions are controlled by either coil control or face-and-bypass control.

In coil control, supply air temperature is controlled by varying the flow rate of cold and hot water in the cooling and heating coils, respectively. As the cooling season gradually changes to heating season, the cooling coil valve is gradually closed and heating coil valve is opened. Though coil control is simpler, using this type of control it is not possible to control the zone humidity precisely as the dehumidification rate in the cooling coil decreases with cold water flow rate. Thus at low cold water flow rates, the humidity ratio of the conditioned space is likely to be higher than required.

In face-and-bypass control, the cold and hot water flow rates are maintained constant, but the amount of air flowing over the coils are decreased or increased by opening or closing the by-pass dampers, respectively. By this method it is possible to control the zone humidity more precisely, however, this type of control occupies more space physically and is also expensive compared to coil control.

Applications of single duct, single zone, constant volume systems:

1. Spaces with uniform loads, such as large open areas with small external loads e.g. theatres, auditoria, and departmental stores.
2. Spaces requiring precision control such as laboratories

The Multiple, single zone systems can be used in large buildings such as factories, office buildings etc.

**Single duct, constant volume, multiple zone systems:**

For very large buildings with several zones of different cooling/heating requirements, it is not economically feasible to provide separate single zone systems for each zone. For such cases, multiple zone systems are suitable. Figure 36.3 shows a single duct, multiple zone system with terminal reheat coils. In these systems all the air is cooled and dehumidified (for summer) or heated and humidified (for winter) to a given minimum or maximum temperature and humidity ratio. A constant volume of this air is supplied to the reheat coil of each zone. In the reheat coil the supply air temperature is increased further to a required level depending upon the load on that particular zone. This is achieved by a zone thermostat, which controls the amount of reheat, and hence the supply air temperature. The reheat coil may run on either electricity or hot water.

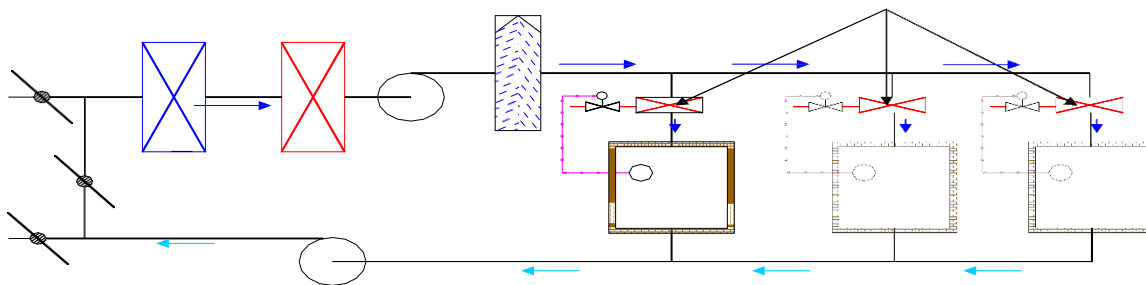

*Single duct, constant volume system with multiple zones and reheat coils*

Advantages of single duct, multiple zone, constant volume systems with reheat coils:

- a) Relatively small space requirement
- b) Excellent temperature and humidity control over a wide range of zone loads
- c) Proper ventilation and air quality in each zone is maintained as the supply air amount is kept constant under all conditions

Disadvantages of single duct, multiple zone, constant volume systems with reheat coils:

- a) High energy consumption for cooling, as the air is first cooled to a very low temperature and is then heated in the reheat coils. Thus energy is required first for cooling and then for reheating.

The energy consumption can partly be reduced by increasing the supply air temperature, such that at least one reheat coil can be switched-off all the time. The energy consumption can also be reduced by using waste heat (such as heat rejected in the condensers) in the reheat coil.

b) Simultaneous cooling and heating is not possible.

### **Single duct, variable air volume (VAV) systems:**

Figure shows a single duct, multiple zone, variable air volume system for summer air conditioning applications. As shown, in these systems air is cooled and dehumidified to a required level in the cooling and dehumidifying coil (CC).

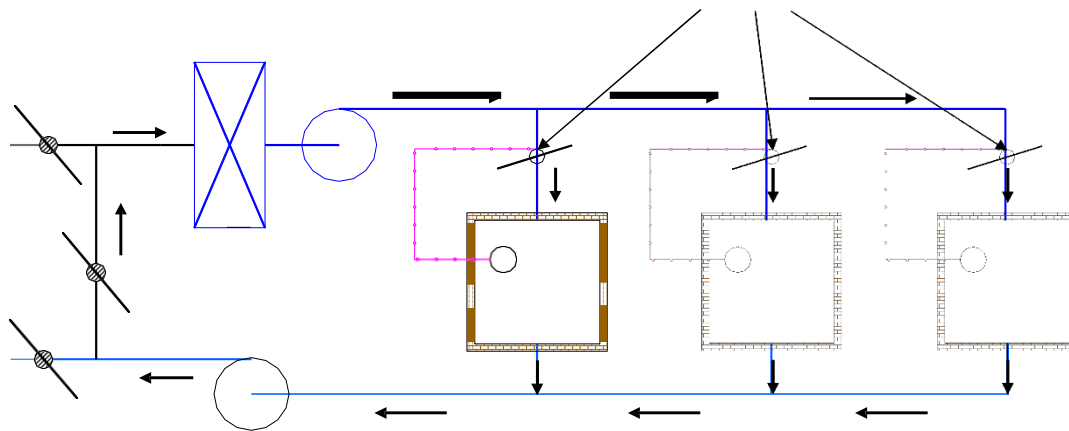

*Single duct, multiple zone, variable air volume system*

Variable volume of this air is supplied to each zone. The amount of air supplied to each zone is controlled by a zone damper, which in turn is controlled by that zone thermostat as shown in the figure. Thus the temperature of supply air to each zone remains constant, whereas its flow rate varies depending upon the load on that particular zone.

Compared to constant volume systems, the variable air volume systems offer advantages such as:

a) Lower energy consumption in the cooling system as air is not cooled to very low temperatures and then reheated as in constant volume systems.

b) Lower energy consumption also results due to lower fan power input due to lower flow rate, when the load is low. These systems lead to significantly lower power consumption, especially in perimeter zones where variations in solar load and outside temperature allows for reduced air flow rates.

However, since the flow rate is controlled, there could be problems with ventilation, IAQ and room air distribution when the zone loads are very low. In addition it is difficult to control humidity precisely using VAV systems. Balancing of dampers could be difficult if the airflow rate varies widely. However, by combining VAV systems with terminal reheat it is possible to maintain the air flow rate at a minimum required level to ensure proper ventilation and room air distribution. Many other variations of VAV systems are available to cater to a wide variety of applications.

**Dual duct, constant volume systems:**

Figure shows the schematic of a dual duct, constant volume system. As shown in the figure, in a dual duct system the supply air fan splits the flow into two streams. One stream flow through the cooling coil and gets cooled and dehumidified to about 13oC, while the other stream flows the heating coil and is heated to about

35–45oC. The cold and hot streams flow through separate ducts. Before each conditioned space or zone, the cold and hot air streams are mixed in required proportions using a mixing box arrangement, which is controlled by the zone thermostat. The total volume of air supplied to each zone remains constant, however, the supply air temperature varies depending upon load.

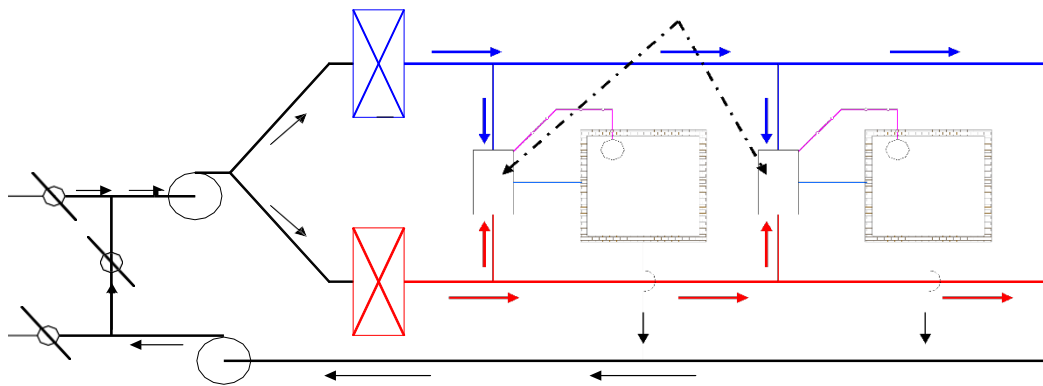

*Dual duct, constant volume system*

Advantages of dual duct systems:

1. Since total airflow rate to each zone is constant, it is possible to maintain proper IAQ and room air distribution.
2. Cooling in some zones and heating in other zones can be achieved simultaneously
3. System is very responsive to variations in the zone load, thus it is possible to maintain required conditions precisely.

Disadvantages of dual duct systems:

1. Occupies more space as both cold air and hot air ducts have to be sized to handle all the air flow rate, if required.
2. Not very energy efficient due to the need for simultaneous cooling and heating of the air streams. However, the energy efficiency can be improved by completely shutting down the cooling coil when the outside temperature is low and mixing supply air from fan with hot air in the mixing box. Similarly, when the outside weather is hot, the heating coil can be completely shut down, and the cold air from the cooling coil can be mixed with supply air from the fan in the mixing box.

**Dual duct, variable air volume systems:**

These systems are similar to dual duct, constant volume systems with the only difference that instead of maintaining constant flow rates to each zone, the mixing boxes reduce the air flow rate as the load on the zone drops.

**Outdoor air control in all air systems:**

As mentioned in a previous lecture, outdoor air is required for ventilation purposes. In all air systems, a sub-system controls the amount of outdoor air by controlling the position of exhaust, re-circulated and outdoor air dampers. From mass balance, since the outdoor airflow rate should normally be equal to the exhaust airflow rate (unless building pressurization or de-pressurization is required), both the exhaust and outdoor air dampers open or close in unison. Again from mass balance, when the outdoor air damper opens the re-circulated air damper closes, and vice versa. The control system maintains a minimum amount of outdoor air (about 10 to

20% of supply air flow rate as required for ventilation) when the outdoor is too cold ( $\leq -30^{\circ}\text{C}$ ) or too warm ( $\geq 24^{\circ}\text{C}$ ). For energy conservation, the amount of outdoor air can be increased gradually as the outdoor air temperature increases from  $-30^{\circ}\text{C}$  to about  $13^{\circ}\text{C}$ . A 100 percent outdoor air can be used when the outdoor air temperature is between  $13^{\circ}\text{C}$  to about  $24^{\circ}\text{C}$ . By this method it is possible to reduce the annual energy consumption of the air conditioning system significantly, while maintaining the required conditions in the conditioned space.

Advantages of all air systems:

1. All air systems offer the greatest potential for energy conservation by utilizing the outdoor air effectively.



2. By using high-quality controls it is possible to maintain the temperature and relative humidity of the conditioned space within  $\pm 0.15^{\circ}\text{C}$  (DBT) and  $\pm 0.5\%$ , respectively.
3. Using dual duct systems, it is possible to provide simultaneous cooling and heating. Change over from summer to winter and vice versa is relatively simple in all air systems.
4. It is possible to provide good room air distribution and ventilation under all conditions of load.
5. Building pressurization can be achieved easily.
6. The complete air conditioning plant including the supply and return air fans can be located away from the conditioned space. Due to this it is possible to use a wide variety of air filters and avoid noise in the conditioned space.

Disadvantages of all air systems:

1. They occupy more space and thus reduce the available floor space in the buildings. It could be difficult to provide air conditioning in high-rise buildings with the plant on the ground floor or basement due to space constraints.
2. Retrofitting may not always be possible due to the space requirement.
3. Balancing of air in large and particularly with variable air volume systems could be difficult.

Applications of all air systems:

All air systems can be used in both comfort as well as industrial air conditioning applications. They are especially suited to buildings that require individual control of multiple zones, such as office buildings, classrooms, laboratories, hospitals, hotels, ships etc. They are also used extensively in applications that require very close control of the conditions in the conditioned space such as clean rooms, computer rooms, operation theatres, research facilities etc.

**All water systems:**

In all water systems the fluid used in the thermal distribution system is water, i.e., water transports energy between the conditioned space and the air conditioning plant. When cooling is required in the conditioned space then cold water is circulated between the conditioned space and the plant, while hot water is circulated through the distribution system when heating is required. Since only water is transported to the conditioned space, provision must be there for supplying required amount of treated, outdoor air to the conditioned space for ventilation purposes. Depending upon the number of pipes used, the all water systems can be classified into a 2-pipe system or a 4-pipe system.

A 2-pipe system is used for either cooling only or heating only application, but cannot be used for simultaneous cooling and heating. Figure 36.6 shows the schematic of a 2-pipe, all water system. As shown in the figure and as the name implies, a 2-pipe system consists of two pipes

– one for supply of cold/hot water to the conditioned space and the other for the return water.

A cooling or heating coil provides the required cold or hot water. As the supply water flows through the conditioned space, required heat transfer between the water and conditioned space takes place, and the return water flows back to the cooling or heating coil. A flow control valve controls the flow rate of hot or cold water to the conditioned space and thereby meets the required building heating or cooling load. The flow control valve is controlled by the zone thermostat. As already mentioned, a separate arrangement must be made for providing the required amount of ventilation air to the conditioned space. A pressure relief valve (PRV) is installed in the water line for maintaining balanced flow rate.

A 4-pipe system consists of two supply pipelines – one for cold water and one for hot water; and two return water pipelines. The cold and hot water are mixed in a required proportion depending upon the zone load, and the mixed water is supplied to the conditioned space. The

return water is split into two streams, one stream flows to the heating coil while the other flows to the cooling coil.

Heat transfer between the cold/hot water and the conditioned space takes place either by convection, conduction or radiation or a combination of these. The cold/hot water may flow through bare pipes located in the conditioned space or one of the following equipment can be used for transferring heat:

1. Fan coil units
2. Convectors
3. Radiators etc.

A fan coil unit is located inside the conditioned space and consists of a heating and/or cooling coil, a fan, air filter, drain tray and controls. Figure 36.7 shows the schematic of a fan coil unit used for cooling applications. As shown in the figure, the basic components of a fan coil unit are: finned tube cooling coil, fan, air filter, insulated drain tray with provision for draining condensate water and connections for cold water lines. The cold water circulates through the finned tube coil while the blower draws warm air from the conditioned space and blows it over the cooling coil. As the air flows through the cooling coil it is cooled and dehumidified. The cold and dehumidified air is supplied to the conditioned space for providing required conditions inside the conditioned space. The water condensed due to dehumidification of room air has to be drained continuously. A cleanable or replaceable filter is located in the upstream of the fan to prevent dust accumulation on the cooling coil and also to protect the fan and motor from dust. Fan coil units for domestic air conditioning are available in the airflow range of 100 to 600 l/s, with multi-speed, high efficiency fans. In some designs, the fan coil unit also consists of a heating coil, which could be in the form of an electric heater or steam or hot water coil. Electric heater is used with 2-pipe systems used with 4-pipe systems. The fan coil units are

either floor mounted, window mounted or ceiling mounted. The capacity of a fan coil unit can be controlled either by controlling the cold water flow rate or by controlling air flow rate or both. The airflow rate can be controlled either by a damper arrangement or by varying the fan speed. The control may be manual or automatic, in which case, a room thermostat controls the capacity. Since in the fan coil unit there is no provision for ventilation, a separate arrangement must be made to take care of ventilation. A fan coil unit with a provision for introducing treated ventilation air to the conditioned space is called as unit ventilator. A convector consists of a finned tube coil through which hot or cold fluid flows. Heat transfer between the coil and surrounding air takes place by natural convection only, hence no fans are used for moving air. Convectors are very widely used for heating applications, and very rarely are used for cooling applications.

In a radiator, the heat transfer between the coil and the surrounding air is primarily by radiation. Some amount of heat is also transferred by natural convection. Radiators are widely used for heating applications, however, in recent times they are also being used for cooling applications.

Advantages of all water systems:

1. The thermal distribution system requires very less space compared to all air systems. Thus there is no penalty in terms of conditioned floor space. Also the plant size will be small due to the absence of large supply air fans.
2. Individual room control is possible, and at the same time the system offers all the benefits of a large central system.
3. Since the temperature of hot water required for space heating is small, it is possible to use solar or waste heat for winter heating.
4. It can be used for new as well existing buildings (retrofitting).

5. Simultaneous cooling and heating is possible with 4-pipe systems.

Disadvantages of all water systems:

1. Requires higher maintenance compared to all air systems, particularly in the conditioned space.
2. Draining of condensate water can be messy and may also create health problems if water stagnates in the drain tray. This problem can be eliminated, if dehumidification is provided by a central ventilation system, and the cooling coil is used only for sensible cooling of room air.
3. If ventilation is provided by opening windows or wall apertures, then, it is difficult to ensure positive ventilation under all circumstances, as this depends on wind and stack effects.
4. Control of humidity, particularly during summer is difficult using chilled water control valves.

Applications of all water systems:

All water systems using fan coil units are most suitable in buildings requiring individual room control, such as hotels, apartment buildings and office buildings.

#### **Air-water systems:**

In air-water systems both air and water are used for providing required conditions in the conditioned space. The air and water are cooled or heated in a central plant. The air supplied to the conditioned space from the central plant is called as primary air, while the water supplied from the plant is called as secondary water. The complete system consists of a central plant for cooling or heating of water and air, ducting system with fans for conveying air, water pipelines and pumps for conveying water and a room terminal. The room terminal may be in the form of a fan coil unit, an induction unit or a radiation panel. Figure shows the schematic of a basic air-

water system. Even though only one conditioned space is shown in the schematic, in actual systems, the air-water systems can simultaneously serve several conditioned spaces.

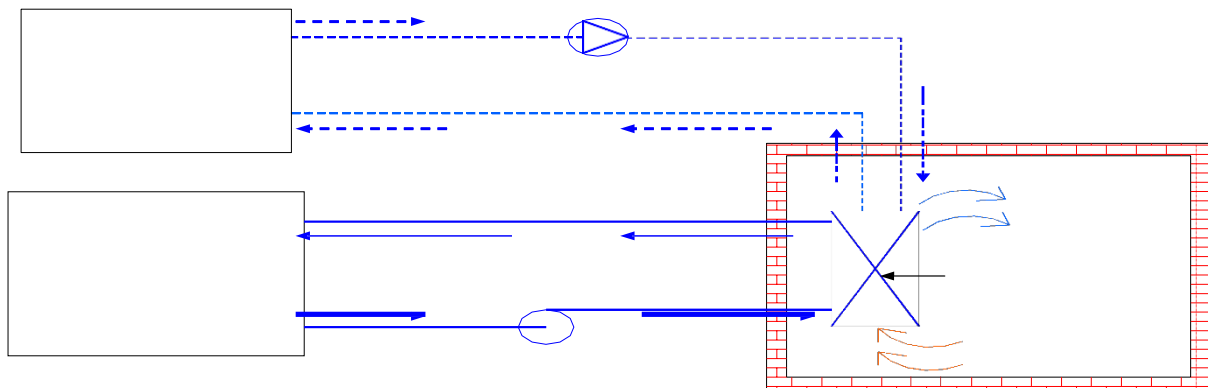

*A basic air-water system*

Normally a constant volume of primary air is supplied to each zone depending upon the ventilation requirement and the required sensible cooling capacity at maximum building load. For summer air conditioning, the primary air is cooled and dehumidified in the central plant, so that it can offset all the building latent load. Chilled water is supplied to the conditioned space to partly offset the building sensible cooling load only. Since the chilled water coil kept in the conditioned space has to take care of only sensible load, condensation of room air inside the conditioned space is avoided thereby avoiding the problems of condensate drainage and related problems in the conditioned space. As mentioned, the primary takes care of the ventilation requirement of the conditioned space, hence unlike in all water systems, there is no need for separate ventilation systems. In winter, moisture can be added to the primary air in the central plant and hot water is circulated through the coil kept in the conditioned space. The secondary water lines can be of 2-pipe, 3-pipe or 4-pipe type similar to all water systems.

As mentioned the room unit may be in the form of a fan coil unit, an induction unit or in the form of a radiant panel. In an induction unit the cooling/heating coil is an integral part of the primary air system. The primary air supplied at medium to high pressure to the induction unit,

induces flow of secondary air from the conditioned space. The secondary air is sensibly cooled or heated as it flows through the cooling/heating coil. The primary and secondary air are mixed and supplied to the conditioned space. The fan coil units are similar to the ones used in all water systems.

Advantages of air-water systems:

1. Individual zone control is possible in an economic manner using room thermostats, which control either the secondary water flow rate or the secondary air (in fan coil units) or both.
2. It is possible to provide simultaneous cooling and heating using primary air and secondary water.
3. Space requirement is reduced, as the amount of primary supplied is less than that of an all air systems.
4. Positive ventilation can be ensured under all conditions.
5. Since no latent heat transfer is required in the cooling coil kept in the conditioned space, the coil operates dry and its life thereby increases and problems related to odours or fungal growth in conditioned space is avoided.
6. The conditioned space can sometimes be heated with the help of the heating coil and secondary air, thus avoiding supply of primary air during winter.
7. Service of indoor units is relatively simpler compared to all water systems.

Disadvantages of air-water systems:

1. Operation and control are complicated due to the need for handling and controlling both primary air and secondary water.

2. In general these systems are limited to perimeter zones.
3. The secondary water coils in the conditioned space can become dirty if the quality of filters used in the room units is not good.
4. Since a constant amount of primary air is supplied to conditioned space, and room control is only through the control of room cooling/heating coils, shutting down the supply of primary air to unoccupied spaces is not possible.
5. If there is abnormally high latent load on the building, then condensation may take place on the cooling coil of secondary water.
6. Initial cost could be high compared to all air systems.

Applications of air-water systems:

These systems are mainly used in exterior buildings with large sensible loads and where close control of humidity in the conditioned space is not required. These systems are thus suitable for office buildings, hospitals, schools, hotels, apartments etc.

**Unitary refrigerant based systems:**

Unitary refrigerant based systems consist of several separate air conditioning units with individual refrigeration systems. These systems are factory assembled and tested as per standard specifications, and are available in the form of package units of varying capacity and type. Each package consists of refrigeration and/or heating units with fans, filters, controls etc. Depending upon the requirement these are available in the form of window air conditioners, split air conditioners, heat pumps, ductable systems with air cooled or water cooled condensing units etc. The capacities may range from fraction of TR to about 100 TR for cooling. Depending upon the capacity, unitary refrigerant based systems are available as single units which cater to a single conditioned space, or multiple units for several conditioned



spaces. Figure 36.9 shows the schematic of a typical window type, room air conditioner, which is available in cooling capacities varying from about 0.3 TR to about 3.0 TR. As the name implies, these units are normally mounted either in the window sill or through the wall. As shown in the figure, this type of unit consists of single package which includes the cooling and dehumidification coil, condenser coil, a hermetic compressor, expansion device (capillary tube), condenser fan, evaporator fan, room air filter and controls. A drain tray is provided at the bottom to take care of the condensate water. Both evaporator and condensers are plate fin-and-tube, forced convection type coils. For rooms that do not have external windows or walls, a split type room air conditioner can be used. In these air conditioners, the condensing unit comprising of the condenser, compressor and condenser fan with motor are located outside, while the indoor unit consisting of the evaporator, evaporator fan with motor, expansion valve and air filter is located inside the conditioned room. The indoor and outdoor units are connected by refrigerant piping. In split type air conditioners, the condensed water has to be taken away from the conditioned space using separate drain pipes. In the room air conditioners (both window mounted and split type), the cooling capacity is controlled by switching the compressor on-and-off. Sometimes, in addition to the on-and-off, the fan speed can also be regulated to have a modular control of capacity. It is also possible to switch off the refrigeration system completely and run only the blower for air circulation.

A typical package unit with a remote condensing unit. As shown, in a typical package unit, the remote condensing unit consists of the compressor and a condenser, while the indoor unit consists of the plate fin-and-tube type, evaporator, a blower, air filter, drain tray and an arrangement for connecting supply air and return air ducts. These units are available in capacities ranging from about 5 TR to upto about 100 TR. The condenser used in these systems could be either air cooled or water cooled. This type of system can be used for providing air conditioning in a large room or it can cater to several small rooms with suitable supply and

return ducts. It is also possible to house the entire refrigeration in a single package with connections for water lines to the water cooled condenser and supply and return air ducts. Larger systems are either constant air volume type or variable air volume type. They may also include heating coils along with the evaporator.

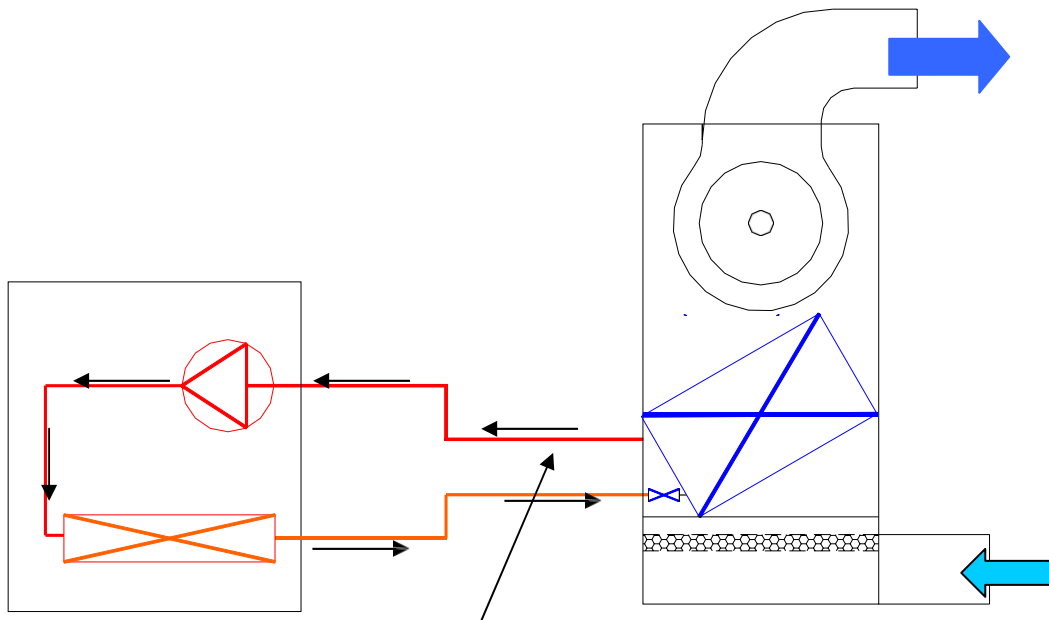

*A typical package unit with remote condensing unit*

Most of the unitary systems have a provision for supplying outdoor air for ventilation purposes. The type of control depends generally on the capacity of the unit. The control system could be as simple as a simple thermostat based on-off control as in room air conditioners to sophisticated microprocessor based control with multiple compressors or variable air volume control or a combination of both.

Advantages of unitary refrigerant based systems:

1. Individual room control is simple and inexpensive.
2. Each conditioned space has individual air distribution with simple adjustment by the occupants.

3. Performance of the system is guaranteed by the manufacturer.
4. System installation is simple and takes very less time.
5. Operation of the system is simple and there is no need for a trained operator.
6. Initial cost is normally low compared to central systems.
7. Retrofitting is easy as the required floor space is small.

Disadvantages of unitary refrigerant based systems:

1. As the components are selected and matched by the manufacturer, the system is less flexible in terms of air flow rate, condenser and evaporator sizes.
2. Power consumption per TR could be higher compared to central systems.
3. Close control of space humidity is generally difficult.
4. Noise level in the conditioned space could be higher.
5. Limited ventilation capabilities.
6. Systems are generally designed to meet the appliance standards, rather than the building standards.
7. May not be appealing aesthetically.
8. The space temperature may experience a swing if on-off control is used as in room air conditioners.
9. Limited options for controlling room air distribution.
10. Equipment life is relatively short.

Applications of unitary refrigerant based systems:

Unitary refrigerant based systems are used where stringent control of conditioned space temperature and humidity is not required and where the initial cost should be low with a small lead time. These systems can be used for air conditioning individual rooms to large office buildings, classrooms, hotels, shopping centers, nursing homes etc. These systems are especially suited for existing building with a limitation on available floor space for air conditioning systems.