

# GOVT POLYTECHNIC, NAYAGARH

## LECTURE NOTES ON MECHATRONICS

**5<sup>TH</sup> SEM MECHANICAL ENGG.**

**PREPARED BY- HIMANSHU PATRA**

# Contents

- 1) Introduction to Mechatronics.....
- 2) Sensors and Transducers
- 3) Actuators-Mechanical, Electrical
- 4) Programmable logic controllers
- 5) Elements of CNC Machines
- 6) Robotics

# CHAPTER 1

## INTRODUCTION TO MECHATRONICS

- Definition of mechatronics
- Advantages & disadvantages of Mechatronics
- Application of Mechatronics
- Scope of Mechatronics in Industrial Sector
- Components of a Mechatronics System
- Importance of mechatronics in automation

## Definition of mechatronics:

\* **Mechatronics**, also called **mechatronics engineering**, is an interdisciplinary branch of engineering that focuses on the integration of mechanical, electronic and electrical engineering systems, and also includes a combination of robotics, electronics, computer science, telecommunications, systems, control, and product engineering.

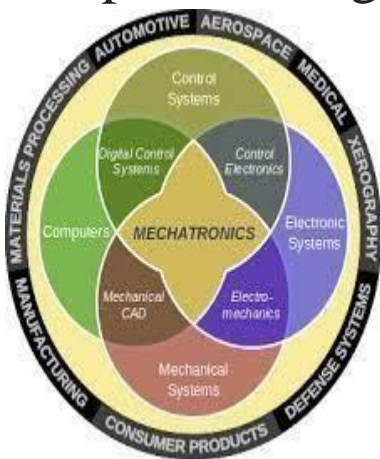

\* It is the extension and the completion of mechanical systems with sensors and microcomputers which is the most important aspect .

# Advantages & disadvantages of Mechatronics

## Advantages of Mechatronics

- High level of integration.
- Increased functionality and better design.
- More use of electronics and software instead of mechanical function.
- Assumes responsibility for process and operation with little interference of operators.
- Uses artificial intelligence and intelligent process control.
- High reliability and safety.
- Improved and less expensive controls.

## Disadvantages of Mechatronics :

- The initial cost is very high.
- The complicated design and system.
- The repair and maintenance is complex.
- Its replacement is so difficult, that it is difficult to change the old system to the new system.

## Application of Mechatronics;

- ❖ Electronic home appliances
- ❖ Electronic entertainment products
- ❖ Engine systems (cars)
- ❖ Large scale application
- ❖ Automotive mechanics
- ❖ VCRs and CD players.
- ❖ Document scanner.

### Mechatronics

#### Application of Mechatronics :

- Automation, part of the robotics.
- Motor which moves a certain amount and angle (Servo-mechanics).
- Remote control systems.
- Automotive engineering, in the sub-systems such as anti-lock braking systems design.
- design mechanisms such as computer disks.
- Vision mechanism
- Industrial goods



## Scope of Mechatronics in Industrial Sector:

- ✧ Better design of products.
- ✧ Better process planning.
- ✧ Reliable and quality oriented manufacturing.
- ✧ Intelligent process control.

## Components of a Mechatronics System

Physically, a mechatronic system is composed of four prime components. They are **sensors, actuators, controllers and mechanical components.**

- (i) Actuators and sensors**
- (ii) Signals and conditioning**
- (iii) Digital logic Systems**
- (iv) Software and data acquisition systems**
- (v) Computers and display devices.**

### (i) Sensors and actuators

Sensors and actuators mostly come under mechanical systems. The actuators produce motion or cause some action. The sensors detect the state of the system parameters, inputs, and outputs. The various actuators used in the mechatronic system are pneumatic and hydraulic actuators, electro-mechanical actuators, electrical motors such as DC motors, AC motors, stepper motors, servomotors, and piezoelectric actuators. The various types of sensors used in the mechatronic system are linear and rotational sensors, acceleration sensors, force, torque and pressure sensors, flow sensors, temperature sensors, proximity sensors, light sensors.

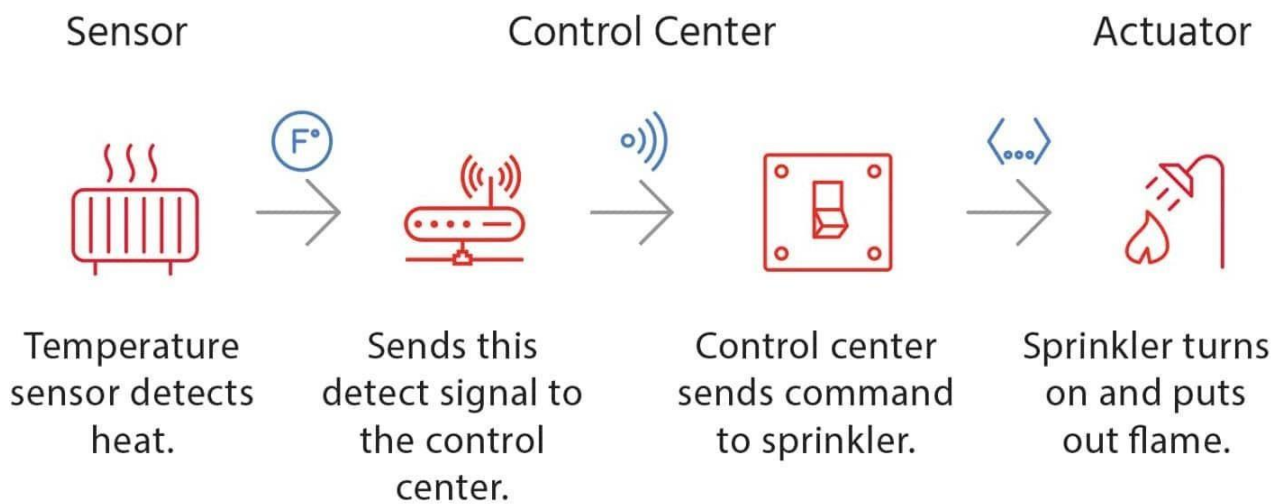

---

## Sensor to **Actuator** Flow



## (ii) Signals and conditioning



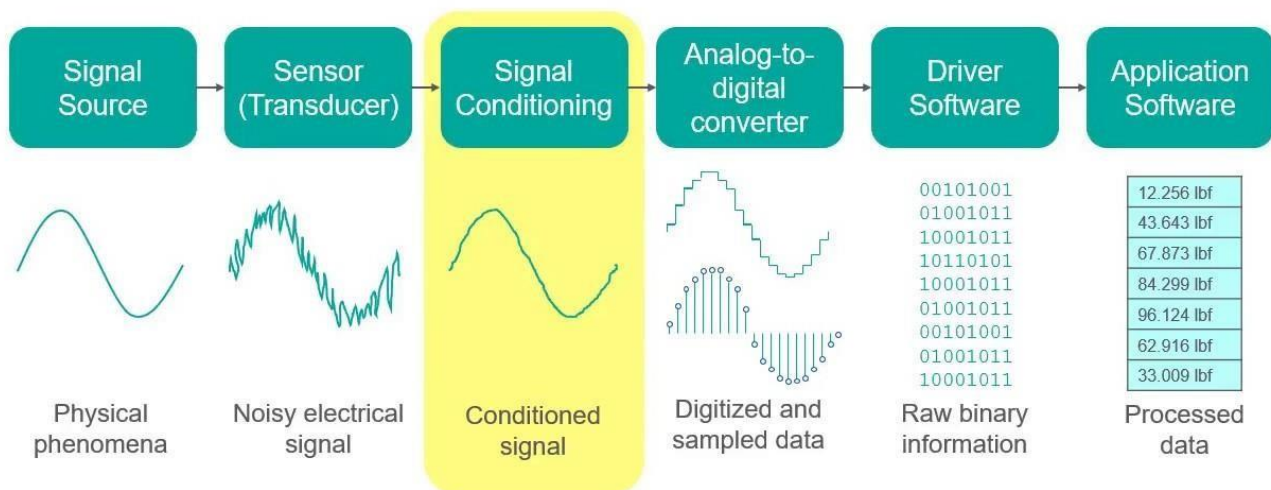

The mechatronic systems deal with two types of signals and conditioning such as – input and output. The input devices receive input signals from the mechatronic systems via interfacing devices and sensors. Then it is sent to the control circuits for conditioning or processing. The various input signal conditioning devices used in the mechatronic system are discrete circuits, amplifiers, Analog-to-Digital (A/D) converters, Digital-to-Digital (DZD) convertors. The output signals from the system are sent to output/display devices through interfacing devices. The various output signal conditioning devices used in the mechatronic system are Digital-to-Analog (D/A) converters, Display Decoders (DD) converters, amplifiers, power transistors, and power op-amps.

### What is Signal Conditioning?



### (iii) Digital logic systems

Digital logic devices control overall system operation. The various digital logic systems used in the mechatronic system are logic circuits, microcontrollers, programmable logic controllers, sequencing and timing controls, and control algorithms.

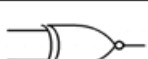
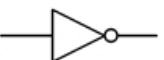
Logic Gate	Symbol	Description	Boolean
AND		Output is at logic 1 when, and only when all its inputs are at logic 1, otherwise the output is at logic 0.	$X = A \cdot B$
OR		Output is at logic 1 when one or more are at logic 1. If all inputs are at logic 0, output is at logic 0.	$X = A + B$
NAND		Output is at logic 0 when, and only when all its inputs are at logic 1, otherwise the output is at logic 1	$X = \overline{A \cdot B}$
NOR		Output is at logic 0 when one or more of its inputs are at logic 1. If all the inputs are at logic 0, the output is at logic 1.	$X = \overline{A + B}$
XOR		Output is at logic 1 when one and Only one of its inputs is at logic 1. Otherwise is it logic 0.	$X = A \oplus B$
XNOR		Output is at logic 0 when one and only one of its inputs is at logic 1. Otherwise it is logic 1. Similar to XOR but inverted.	$X = \overline{A \oplus B}$
NOT		Output is at logic 0 when its only input is at logic 1, and at logic 1 when its only input is at logic 0. That's why it is called and INVERTER	$X = \overline{A}$

#### (iv) Software and data acquisition systems

The data acquisition system acquires the output signals from sensors in the form of voltage, frequency, resistance etc. and it is inputted into the microprocessor or computer. Software is used to control the acquisition of data through the DAC board. The data acquisition system consists of a multiplexer, amplifier, register, and control circuitry., and DAC board. The various data acquisition systems used in the mechatronic system is data loggers, computer with plug-in boards, etc.

### Digital Data Acquisition System

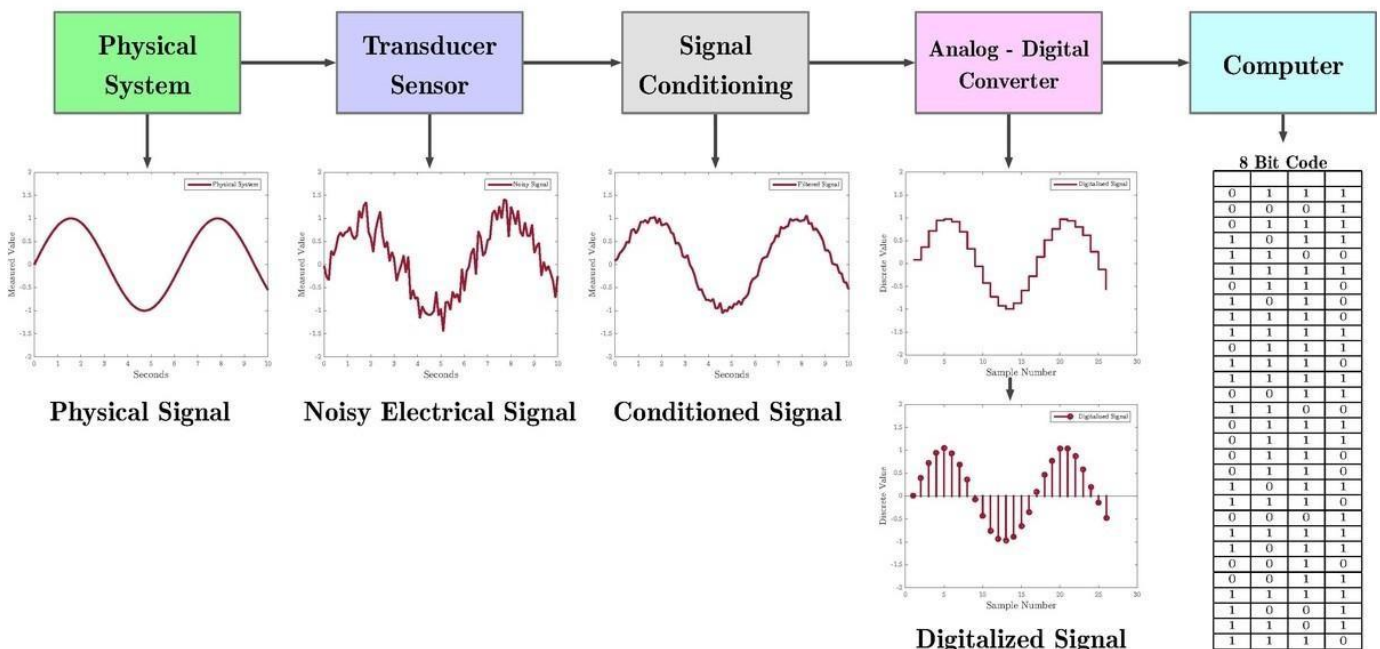

### (v) Computers and display devices

Computers are used to store a large number of data and process further through software. Display devices are used to give visual feedback to the user. The various display devices used in the mechatronic system are LEDs, CRT, LCD, digital displays, etc.

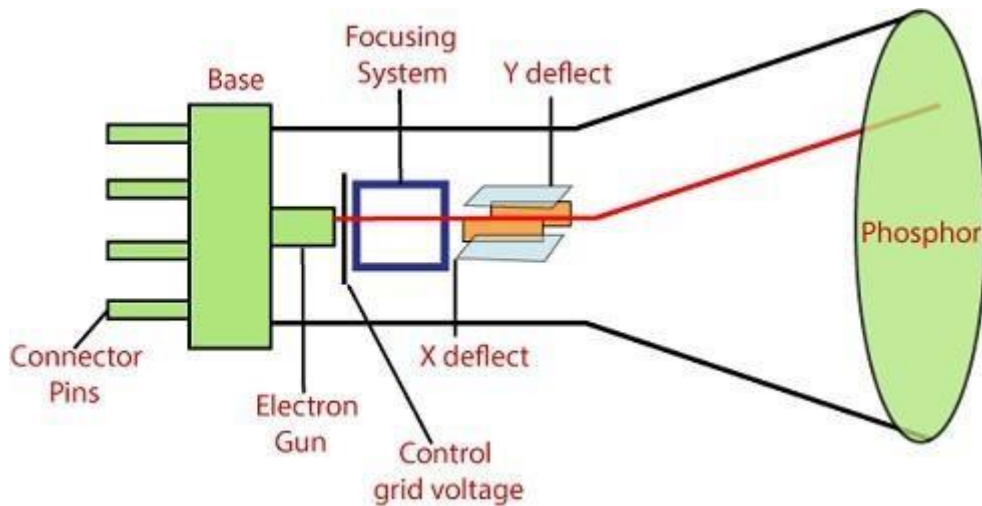

## Importance of mechatronics in automation

- \* Mechatronics based automated systems such as **automatic inspection and quality assurance**, automatic packaging, record making, and automatic dispatch help to expedite the entire manufacturing operation.
- \* These systems certainly ensure a supply better quality, well packed and reliable products in the market.
- \* Mechatronics and Automation is an integrative branch of engineering that incorporates **learning principles from Mechanical, Electrical, Control, Robotics, Electronic, Computer, Telecommunication, Systems, and Product Engineering.**

# CHAPTER 2

## Sensors and Transducers

Definition of Transducers

Classification of Transducers

Electromechanical Transducers

Transducers Actuating Mechanisms

Displacement & Positions Sensors

Velocity, motion, force and pressure sensors.

Temperature and light sensors.

## Defination of Transducers

A transducer is a device that converts energy from one form to another. Usually a transducer converts a signal in one form of energy to a signal in another.

Transducers are often employed at the boundaries of automation, measurement, and control systems, where electrical signals are converted to and from other physical quantities (energy, force, torque, light, motion, position, etc.). The process of converting one form of energy to another is known as transduction.

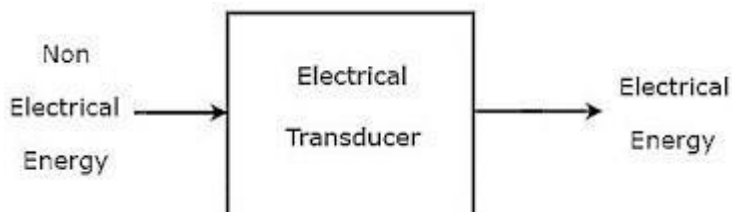

# Classification of Transducers

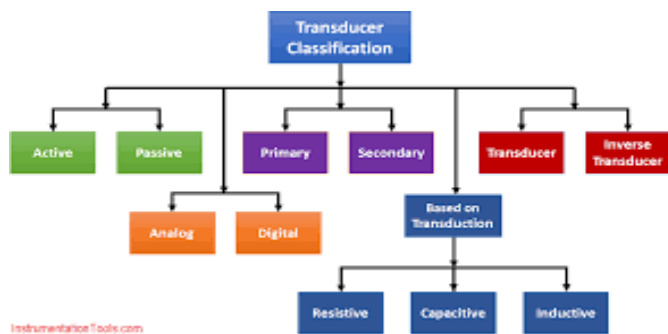

Classification of Transducers: There are many principles on which a transducer can work like resistive, inductive, capacitive etc. So Transducer can be categorized on the basis of four thoughts. On the basis of transduction form it's used, we can go further.

1. Primary and secondary type
2. Analog and digital type
3. Active and passive type
4. Transducer and Inverse type .



**Primary and Secondary Transducer:** Suppose you need to measure pressure. In this case we use bourdon tube .So bourdon tube acts as primary transducer; it senses the pressure and converts pressure into displacement of its free end. The displacement of the free end moves the core of the linear variable differential transducer which produces output voltage proportional to movement of core which is proportional to movement of core which is again proportional to pressure. So we are able to measure pressure. Here bourdon tube is the primary transducer and LVDT is secondary transducer.

**Analog and Digital Transducer:** Transducers converting input quantity to analog output in the form of pulses are analog transducers. I.E. Strain gauge, thermocouple etc. digital transducers convert input to electrical output in form of pulses.

**Active and Passive Transducer:** Active transducers are those which don't need auxiliary power source to produce output. The energy required for production of output signal is obtained from physical quantities being measured. I.E. piezoelectric crystals, tacho-generators etc. Passive transducers are those which need an auxiliary power source to produce output. I.E. linear potentiometer etc

**Transducers and Inverse transducer:** Transducers, as mentioned earlier convert non electrical quantity to electrical quantity whereas inverse transducer converts electrical to non-electrical quantity. This type of transducer converts electrical signals into required form. I.E. Piezoelectric Crystal. It converts electrical signals into mechanical vibration.

## Electromechanical Transducers

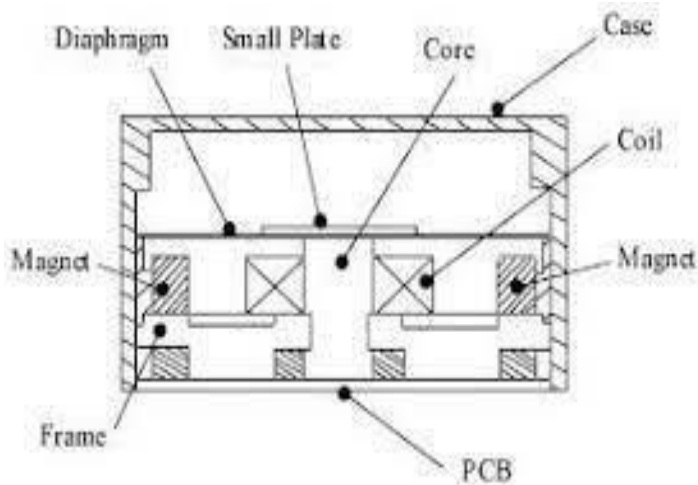

Dielectric elastomer (DE) are electromechanical transducers that convert or *transduce* electrical energy to or from mechanical energy. In an actuator mode, DEs convert electrical to mechanical energy, whereas in a generator mode they perform the reverse function and convert mechanical to electrical energy. This chapter derives the fundamental equations describing DE transduction. The equations show quantitatively how electrical parameters such as electric field and dielectric constant are related to mechanical parameters such as stress and strain. The basic equations can be extended to examine more subtle considerations such as film stability and leakage, as well as applied to devices such as sensors and variable stiffness devices that transduce mechanical energy both to *and* from electrical energy.

## Transducers Actuating Mechanisms

Transducers are also known as gauges, pick up and signal generators.

1. Activating devices
2. Transducing elements

In order to excite a traveling wave in the cylinder, two standing waves, the amplitudes of which are equal, and their phase difference on time and space is  $\pi/2$ , are generated by the longitudinal and bending vibration of the transducer, respectively. The longitudinal vibration of the transducer is excited by the longitudinal vibration of longitudinal PZT. The bending PZT is located at the antinodal plane of the bend wave of the transducer, and the bending vibration of the transducer is excited by the longitudinal vibration of bending PZT. Thus, the composite transducer should be excited with two-phase alternating voltages. When a flexural traveling wave is excited in the cylinder, elliptical trajectories are achieved at the particles on the teeth. And the driving force is the frictional force between the rotor and teeth.

## Displacement & Positions Sensors

### **What is a Displacement Transducer?**

**A Displacement Transducer is an electromechanical device used to convert mechanical motion or vibrations, specifically rectilinear motion, into a variable electrical current, voltage or electric signals, and the reverse. Actuating mechanisms used primarily for automatic control systems or as mechanical motion sensors in measurement technologies. The classification of electromechanical transducers includes conversion principles or types of output signals.**



## What is a Position Transducer?

A position transducer typically consists of two fundamental parts. One part remains fixed in position while the other part moves with the mechanism whose displacement is being measured. The exact nature, and therefore the size, of the fixed and moving portions depend on the sensing technology being used. Some transducers are intended to be mounted integrally to the mechanism, while others are designed to be mounted externally.

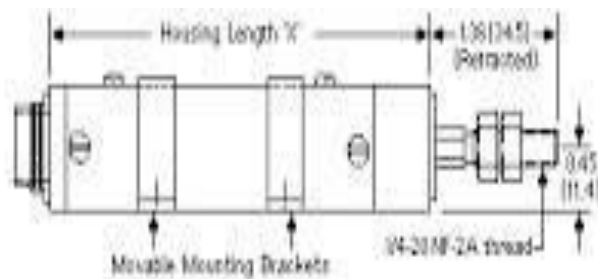

# Velocity, motion, force and pressure sensors.

## Velocity Sensor

A velocity receiver (velocity sensor) is **a sensor that responds to velocity rather than absolute position.** For example, dynamic microphones are velocity receivers. ... Movement causes the coil to move relative to the magnet, which in turn generates a voltage that is proportional to the velocity of that movement.

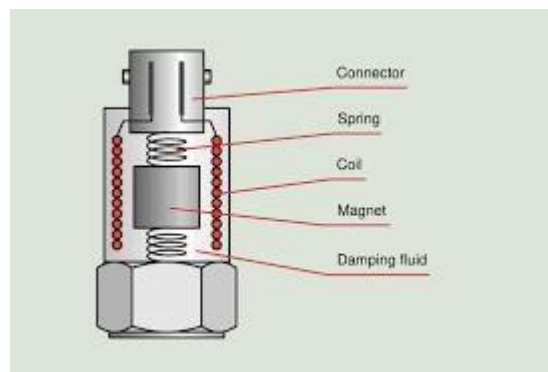

## Motion sensors

A motion sensor (or motion detector) is an electronic device that is designed to detect and measure movement. Motion sensors are used primarily in home and business security systems, but they can also be found in phones, paper towel dispensers, game consoles, and virtual reality systems. Unlike many other types of sensors (which can be handheld and isolated), motion sensors are typically embedded systems with three major components:

a **sensor** unit, an **embedded computer**, and hardware (or the mechanical component).





## Force Sensor

A Force Sensor is defined as a **transducer that converts an input mechanical load, weight, tension, compression or pressure into an electrical output signal** (load cell definition). Force Sensors are also commonly known as Force Transducers. There are several types of load cells based on size, geometry and capacity.



## Pressure sensor

A **pressure sensor** is a device for pressure measurement of gases or liquids. Pressure is an expression of the force required to stop a fluid from expanding, and is usually stated in terms of force per unit area. A pressure sensor usually acts as a transducer; it generates a signal as a function of the pressure imposed. For the purposes of this article, such a signal is electrical

Pressure sensors can also be used to indirectly measure other variables such as fluid/gas flow, speed, water level, and altitude. Pressure sensors can alternatively be called **pressure transducers, pressure transmitters, pressure senders, pressure indicators, piezometers** and **manometers**, among other names.



## Temperature and light sensors.

### Temperature sensor

A temperature sensor is a **device used to measure temperature**. This can be air temperature, liquid temperature or the temperature of solid matter. There are different types of temperature sensors available and they each use different technologies and principles to take the temperature measurement.

A temperature sensor is an electronic device that measures the temperature of its environment and converts the input data into electronic data to record, monitor, or signal temperature changes. There are many different types of temperature sensors. Some temperature sensors require **direct contact** with the physical object that is being monitored (contact temperature sensors), while others indirectly measure the temperature of an object (non-contact temperature sensors).



## Light sensor

The light sensor is a **passive device that converts the light energy into an electrical signal output**. Light sensors are more commonly known as Photoelectric Devices or Photo Sensors because they convert light energy (photons) into electronic signals (electrons) The sensor receives the light reflected from the target.

A **Light Sensor** generates an output signal indicating the intensity of light by measuring the radiant energy that exists in a very narrow range of frequencies basically called “light”, and which ranges in frequency from “Infra-red” to “Visible” up to “Ultraviolet” light spectrum.

The light sensor is a passive device that converts this “light energy” whether visible or in the infra-red parts of the spectrum into an electrical signal output. Light sensors are more commonly known as “Photoelectric Devices” or “Photo Sensors” because they convert light energy (photons) into electricity (electrons).



# CHAPTER 3

## Actuators-Mechanical, Electrical

### Mechanical Actuators

Machine, Kinematic Link, Kinematic Pair

Mechanism, Slider crank Mechanism

Gear Drive, Spur gear, Bevel gear, Helical gear, wormgear

Belt & Belt drive

Bearings

### Electrical Actuator

Switches and relay

Solenoid

D.C Motors

A.C Motors

Specification and control of stepper motor

Servo Motors D.C & A.C

# Mechanical Actuators

Machine, Kinematic Link,  
Kinematic Pair

Machine :-

A machine (or mechanical device) is a **mechanical structure that uses power to apply forces and control movement to perform an intended action**

An apparatus using mechanical power and having several parts, each with a definite function and together performing a particular task..



## KINEMATIC LINK :-

It is defined as the part of machine which has a relative motion with respect to some other part of same machine is called Kinematic link or element

**In mechanical engineering, a kinematic chain is an assembly of rigid bodies connected by joints to provide constrained motion that is the mathematical model for a mechanical system.**

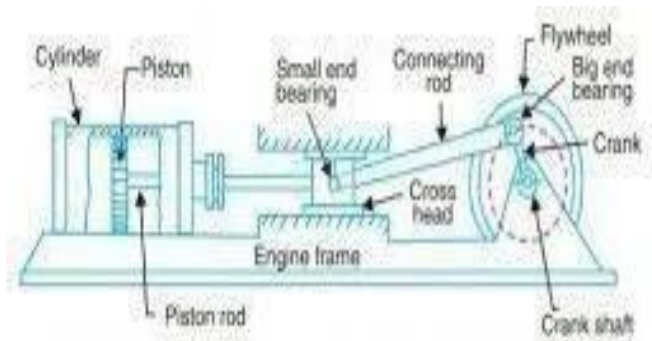
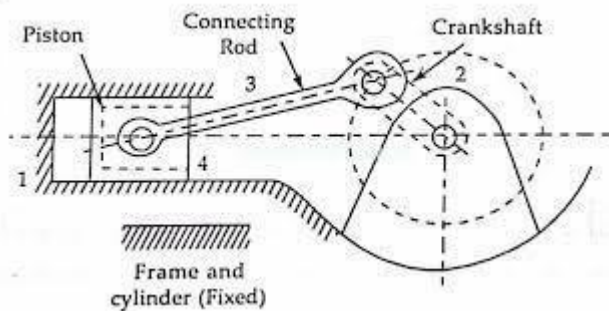

# Kinematic Pair :-

The two links or elements of a machine, when in contact with each other, are said to form a pair. If the relative motion between them is completely or successfully constrained the pair is known as kinematic pair.

The two links or elements of a machine, when in contact with each other, are said to form a pair. If the relative motion between them is completely or successfully constrained (i.e. in a definite direction), the pair is known as kinematic pair.

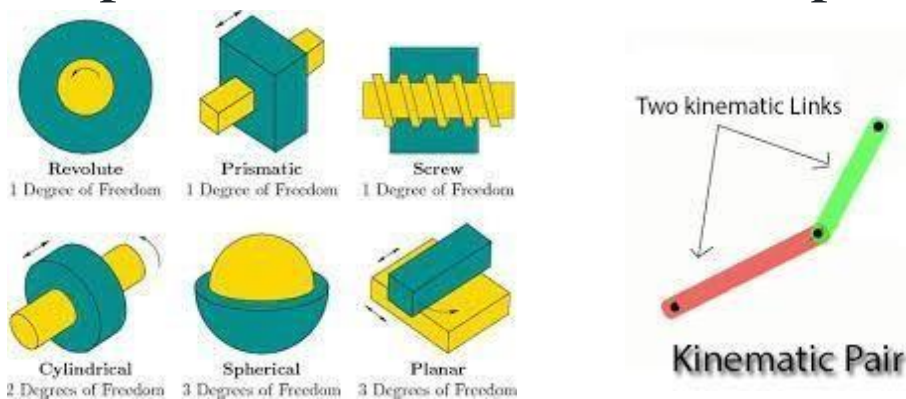



# Mechanism, Slider crank Mechanism

## Mechanism

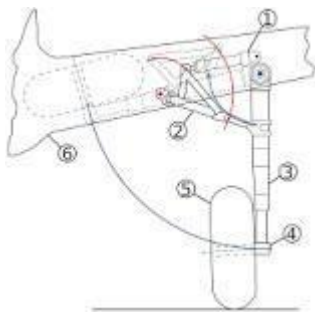

A mechanism is usually a piece of a larger process, known as a mechanical system or machine. Sometimes an entire machine may be referred to as a mechanism; examples are the **steering mechanism in a car**, or the winding mechanism of a wristwatch.

**The way in which the parts of a machine are interconnected and guided to produce a required output motion from a given input motion is known as the mechanism of the machine. ...**

# Slider-crank mechanism

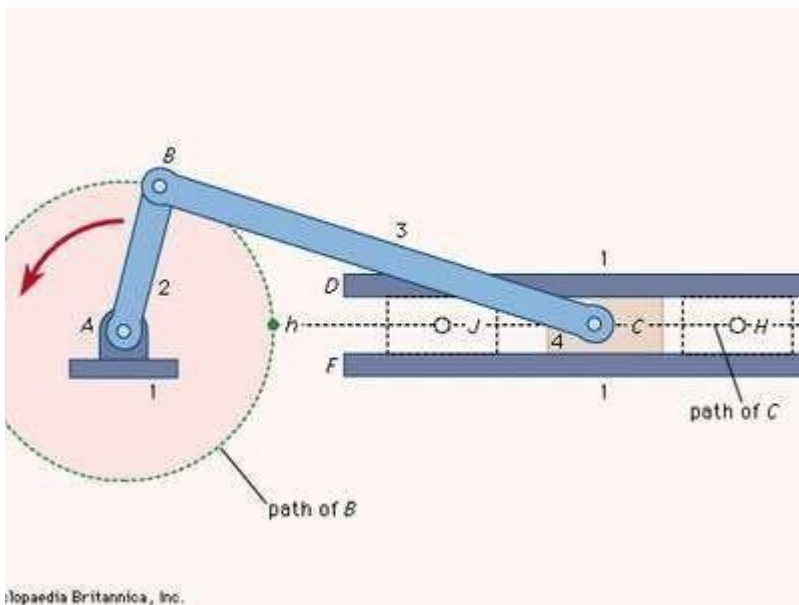

Arrangement of mechanical parts designed to convert straight-line motion to rotary motion, as in a reciprocating piston engine, or to convert rotary motion to straight-line motion, as in a reciprocating piston pump. The basic nature of the mechanism and the relative motion of the parts

Slider-crank mechanism, **arrangement of mechanical parts designed to convert straight-line motion to rotary motion**, as in a reciprocating piston engine, or to convert rotary motion to straight-line motion, as in a reciprocating piston pump.

# Gear Drive, Spur gear, Bevel gear, Helical gear, worm gear

## Gear Drive

Same sized and shaped teeth cut at equal distances along a flat surface or a straight rod is called a gear rack. A gear rack is a cylindrical gear with the radius of the pitch cylinder being infinite. By meshing with a cylindrical gear pinion, it converts rotational motion into linear motion. Gear racks can be broadly divided into straight tooth racks and helical tooth racks, but both have straight tooth lines. By machining the ends of gear racks, it is possible to connect gear racks end to end.

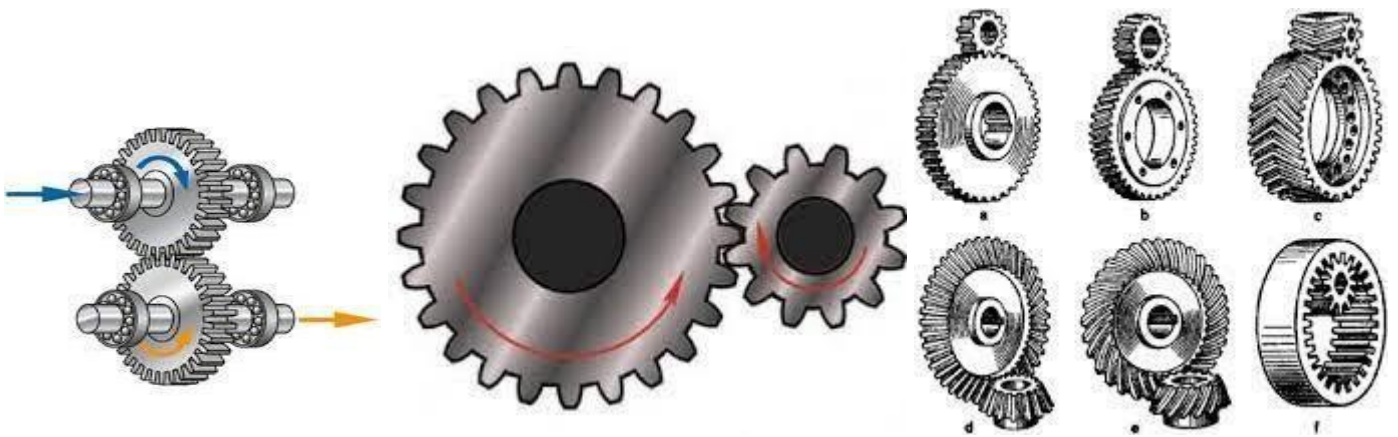

# Spur gear

Gears having cylindrical pitch surfaces are called cylindrical gears. Spur gears belong to the parallel shaft gear group and are cylindrical gears with a tooth line which is straight and parallel to the shaft. Spur gears are the most widely used gears that can achieve high accuracy with relatively easy production processes. They have the characteristic of having no load in the axial direction (thrust load). The larger of the meshing pair is called the gear and smaller is called the pinion.

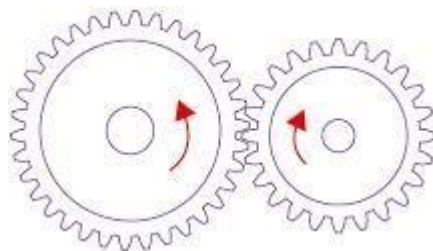

# Bevel gear

Bevel gears have a cone shaped appearance and are used to transmit force between two shafts which intersect at one point (intersecting shafts). A bevel gear has a cone as its pitch surface and its teeth are cut along the cone. Kinds of bevel gears include straight bevel gears, helical bevel gears, spiral bevel gears, miter gears, angular bevel gears, crown gears, zerol bevel gears and hypoid gears.



# Helical gear

Helical gears are used with parallel shafts similar to spur gears and are cylindrical gears with winding tooth lines. They have better teeth meshing than spur gears and have superior quietness and can transmit higher loads, making them suitable for high speed applications. When using helical gears, they create thrust force in the axial direction, necessitating the use of thrust bearings. Helical gears come with right hand and left hand twist requiring opposite hand gears for a meshing pair.

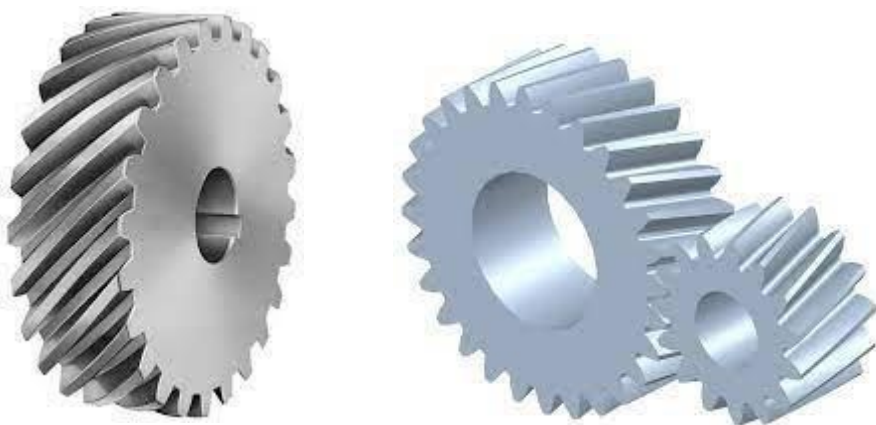

## Worm gear

A screw shape cut on a shaft is the worm, the mating gear is the worm wheel, and together on non-intersecting shafts is called a worm gear. Worms and worm wheels are not limited to cylindrical shapes. There is the hour-glass type which can increase the contact ratio, but production becomes more difficult. Due to the sliding contact of the gear surfaces, it is necessary to reduce friction. For this reason, generally a hard material is used for the worm, and a soft material is used for worm wheel. Even though the efficiency is low due to the sliding contact, the rotation is smooth and quiet. When the lead angle of the worm is small, it creates a self-locking feature.

# Belt & Belt drive

## Belt ;

A **belt** is a loop of flexible material used to link two or more rotating shafts mechanically, most often parallel. Belts may be used as a source of motion, to transmit power efficiently or to track relative movement. Belts are looped over pulleys and may have a twist between the pulleys, and the shafts need not be parallel.

In a two pulley system, the belt can either drive the pulleys normally in one direction (the same if on parallel shafts), or the belt may be crossed, so that the direction of the driven shaft is reversed (the opposite direction to the driver if on parallel shafts). As a source of motion, a conveyor belt is one application where the belt is adapted to carry a load continuously between two points. The belt drive can also be used to change the speed of rotation, either up or down, by using different sized pulleys.

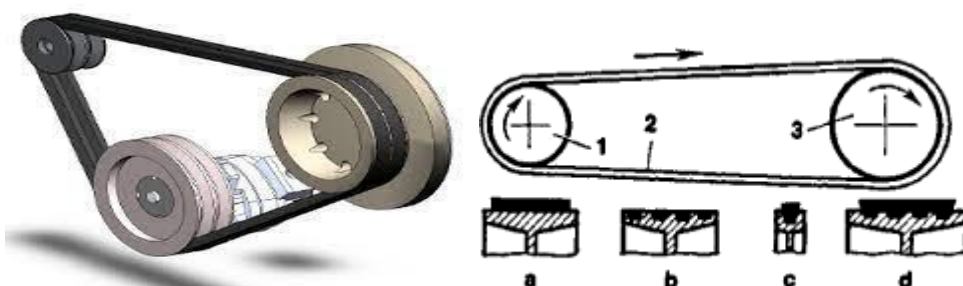



# Belt drive

**Belt drive**, in machinery, a pair of pulleys attached to usually parallel shafts and connected by an encircling flexible belt (band) that can serve to transmit and modify rotary motion from one shaft to the other. Most belt drives consist of flat leather, rubber, or fabric belts running on cylindrical pulleys or of belts with a V-shaped cross section running on grooved pulleys. To create an effective frictional grip on the pulleys, belts must be installed with a substantial tension. Because of the wedging action of the belts in the grooves, V belts require less tension than do flat belts and are particularly suitable for connecting shafts that are close together. Flat and V belts slip when overloaded, and in some applications this condition may be more desirable than a rigid drive because it limits the transmitted torque and may prevent breakage of parts.



# Bearings

A **bearing** is a machine element that constrains relative motion to only the desired motion, and reduces friction between moving parts. The design of the bearing may, for example, provide for free linear movement of the moving part or for free rotation around a fixed axis; or, it may *prevent* a motion by controlling the vectors of normal forces that bear on the moving parts. Most bearings facilitate the desired motion by minimizing friction. Bearings are classified broadly according to the type of operation, the motions allowed, or to the directions of the loads (forces) applied to the parts.



The term "bearing" is derived from the verb "to bear" a bearing being a machine element that allows one part to bear (i.e., to support) another. The simplest bearings are bearing surfaces, cut or formed into a part, with varying degrees of control over the form, size, roughness and

location of the surface. Other bearings are separate devices installed into a machine or machine part. The most sophisticated bearings for the most demanding applications are very precise devices; their manufacture requires some of the highest standards of current technology.

# Electrical Actuator

## Switches and relay SWITCHES :-

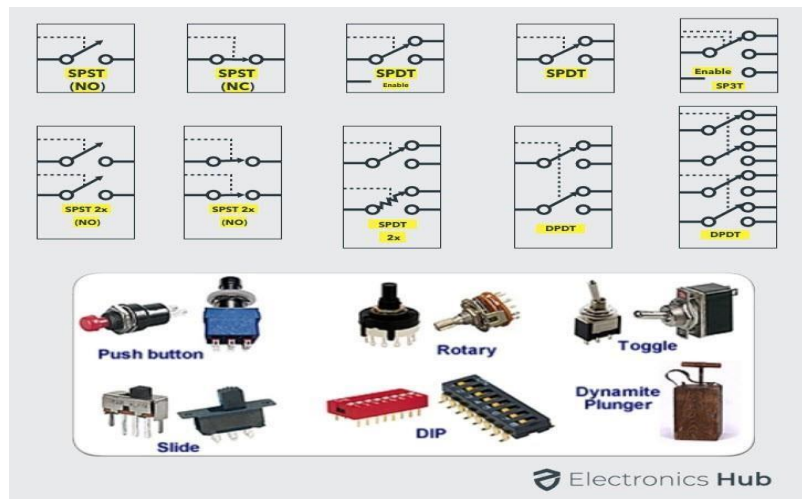

A switch is an electromechanical device used to make or break the circuits.

- ★ Switches can be controlled mechanically
- ★ It controls the flow of current by opening or closing of circuits
- ★ They are operated manually by a lever or by pushing the buttons
- ★ It is used to open or close the contacts
- ★ It operates slowly when compared to relay because it requires a physical object to make the changes
- ★ A switch makes a direct contact or connection
- ★ Example: Manual control of switch (Physical control of fans, lights in Homes)

# ★ RELAY :-

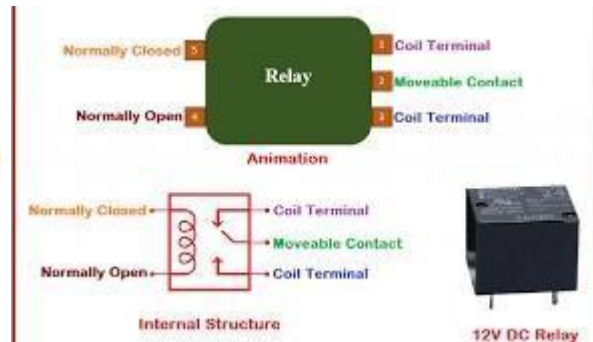

- ❖ Relay is an electromechanical device used to make or break the circuits
- ❖ Relays can be controlled electronically
- ❖ It controls high power circuits with low power signals by opening or closing the contacts
- ❖ It can send electromagnetic or optical signal to actuate the load circuit
- ❖ It is used to protect the system from damage
- ❖ It operates faster
- ❖ It is a remote control switch
- ❖ Example: To turn ON/OFF Air Conditioner, LDR street light (Automatic)

# Solenoid

A solenoid is a device comprised of a coil of wire, the housing and a moveable plunger (armature). When an electrical current is introduced, a magnetic field forms around the coil which draws the plunger in. More simply, a solenoid converts electrical energy into mechanical work.

- The coil is made of many turns of tightly wound copper wire. When an electrical current flows through this wire, a strong magnetic field/flux is created.
- The housing, usually made of iron or steel, surrounds the coil concentrating the magnetic field generated by the coil.
- The plunger is attracted to the stop through the concentration of the magnetic field providing the mechanical force to do work.

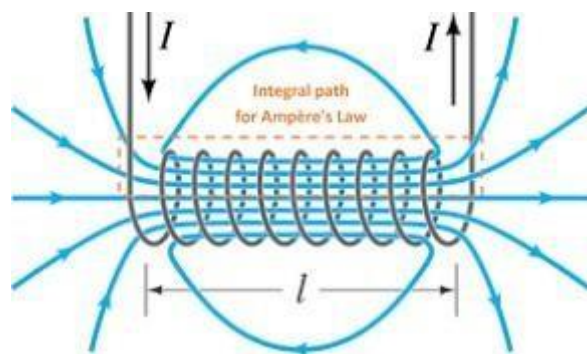
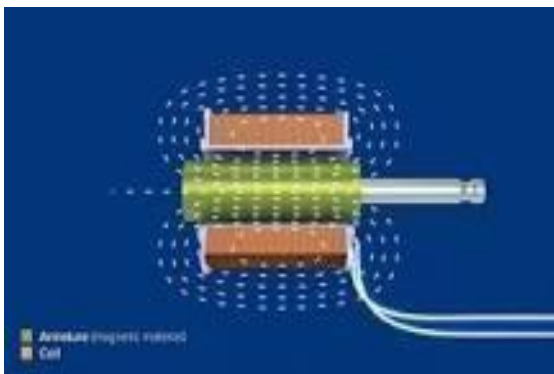

When an electrical current is introduced, a magnetic field forms around the coil which draws the plunger in. More simply, a solenoid **converts electrical energy into mechanical work..**

## D.C Motors

A **DC motor** is any of a class of rotary electrical motors that converts direct current electrical energy into mechanical energy. The most common types rely on the forces produced by magnetic fields. Nearly all types of DC motors have some internal mechanism, either electromechanical or electronic, to periodically change the direction of current in part of the motor.

DC motors were the first form of motor widely used, as they could be powered from existing direct-current lighting power distribution systems. A DC motor's speed can be controlled over a wide range, using either a variable supply voltage or by changing the strength of current in its field windings. Small DC motors are used in tools, toys, and appliances. The universal motor can operate on direct current but is a lightweight brushed motor used for portable power tools and appliances. Larger DC motors are currently used in propulsion of electric vehicles, elevator and hoists, and in drives for steel rolling mills. The advent of power electronics has made replacement of DC motors with AC motors possible in many applications.

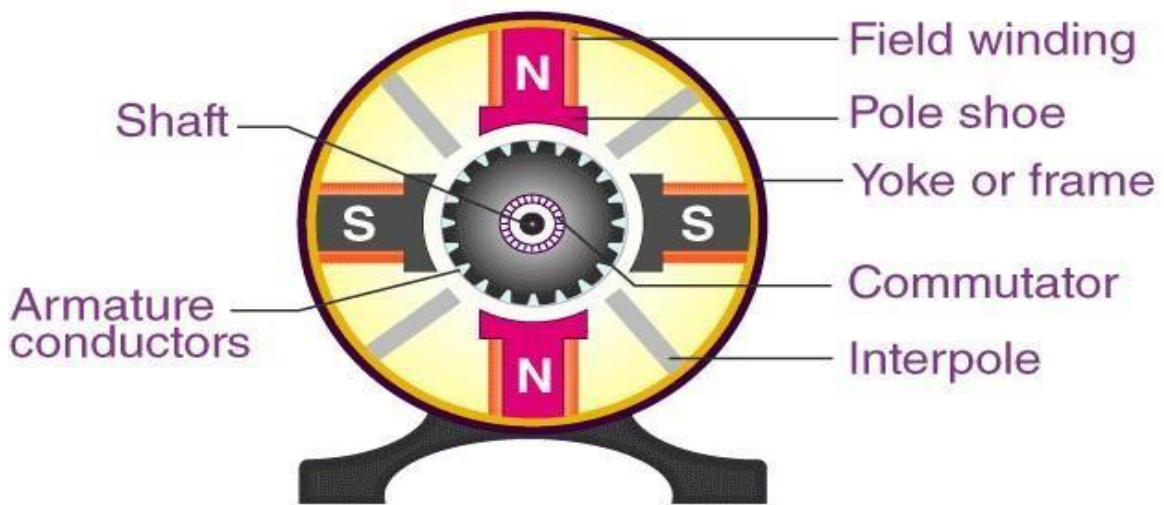

DC motor construction parts

**A DC motor is defined as a class of electrical motors that convert direct current electrical energy into mechanical energy.**

From the above definition, we can conclude that any electric motor that is operated using direct current or DC is called a DC motor. We will understand the DC motor construction and how a DC motor converts the supplied DC electrical energy into mechanical energy in the next few sections.



## A.C Motors

An AC motor is an electric machine that converts alternating current into mechanical rotation. AC motor's applications range from industrial bulk power conversion from electrical to mechanical to household small power conversion. In this article, let us briefly discuss the various traits and working of an AC motor.

An AC motor is a motor that converts the alternating current into mechanical power. The stator and the rotor are important parts of AC motors. The stator is the stationary part of the motor, and the rotor is the rotating part of the motor. The AC motor may be single-phase or three-phase. Nikola Tesla invented the first AC induction motor in 1887.

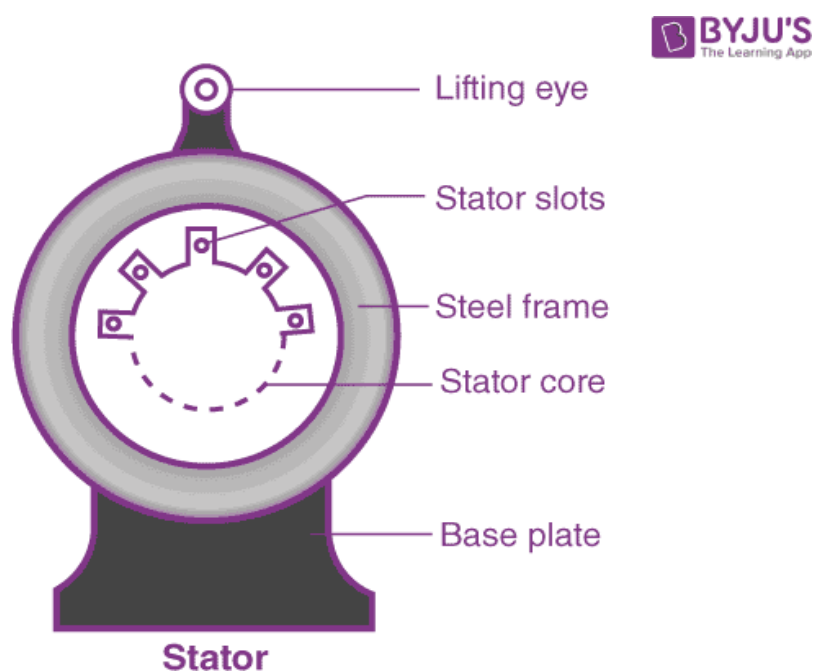

The two main types of AC motors are **induction motors and synchronous motors**. The induction motor (or asynchronous motor) always relies on a small difference in speed between the stator rotating magnetic field and the rotor shaft speed called slip to induce rotor current in the rotor AC winding.

## Specification and control of stepper motor

### Specifications

- Size: 42.3 mm square × 48 mm, not including the shaft (NEMA 17)
  - Weight: 350 g (13 oz)
  - Shaft diameter: 5 mm “D”
  - Steps per revolution: 200
  - Current rating: 1.2 A per coil
  - Voltage rating: 4 V
  - Resistance: 3.3  $\Omega$  per coil
  - Holding torque: 3.2 kg-cm (44 oz-in)
  - Inductance: 2.8 mH per coil
  - Lead length: 30 cm (12")
  - Output shaft supported by two ball bearings

- Control of stepper motor

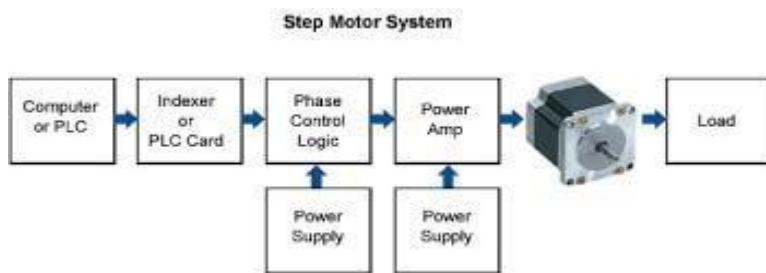

Stepper motor control constant voltage drives are used to apply a constant positive or negative voltage to each winding to drive motion. However, it is winding current, not voltage, that applies torque to the stepper motor shaft. The current ( $I$ ) in each winding is related to the applied voltage ( $V$ ) by the winding inductance ( $L$ ) and the winding resistance ( $R$ ). Thus, these are also known as L/R drives. To obtain high torque at high speeds requires a large drive voltage with a low resistance and low inductance. With an L/R drive it is possible to control a low voltage resistive motor with a higher voltage drive simply by adding an external resistor in series with each winding. However, since it wastes power in the resistors, and generates heat, it is therefore considered a low-performing option.

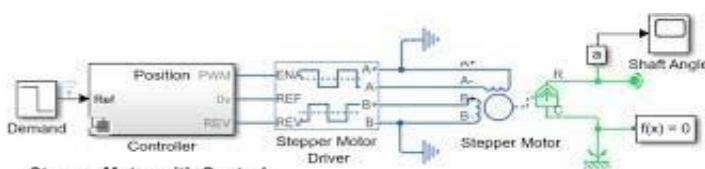

**Stepper Motor with Control**

1. Plot angular speed of motor shaft (see code)
2. Plot voltages of stepper motor driver pins (see code)
3. Configure stepper controller: Speed, Position
4. Explore simulation results using sactexplorer
5. Learn more about this example

How can we control the speed of a stepper motor?

Speed of a stepper motor can be controlled by **changing its switching speed or by changing the length of the time delay loop.**

A stepper motor is a permanent magnet or variable reluctance dc motor that has the following performance characteristics:

- 1.rotation in both directions,
- 2.precision angular incremental changes,
- 3.repetition of accurate motion or velocity profiles,
- 4.a holding torque at zero speed, and
- 5.capability for digital control.

A stepper motor can move in accurate angular increments known as steps in response to the application of digital pulses to an electric drive circuit from a digital controller.

The number and rate of the pulses control the position and

speed of the motor shaft. Generally, stepper motors are manufactured with steps per revolution of 12, 24, 72, 144, 180, and 200, resulting in shaft increments of 30, 15, 5, 2.5, 2, and 1.8 degrees per step.

Stepper motors are either **bipolar**, requiring two power sources or a switchable polarity power source, or **unipolar**, requiring only one power source. They are powered by dc current sources and require digital circuitry to produce the coil energizing sequences for rotation of the motor. The advantage of operating without feedback is that a closed loop control system is not required. Generally, stepper motors produce less than 1 horsepower(746W) and are therefore frequently used in low-power position control applications.

# Servo Motors D.C & A.C

## difference between AC Servo Motor and DC Servo Motor



Characteristics	AC Servo Motor	DC Servo Motor
Efficiency	Low (about 5-20%)	High
Speed & Torque	Adaptable to strong torque and high-speed working condition.	Adaptable to a limited torque and speed.
Stability	Less stability issues	More problems of stability
Noise	No radio frequency noise	Brushes cause radio frequency noise
Operation	Have stable and smooth operation	Noisy operation
Weight & Size	Lighter weight and small in size	Heavy weight and large in size
Repair & Maintenance	Since no commutators, Less maintenance is required	Because of commutation process, regular maintenance is needed.
Output Power	Deliver low power normally between 0.5W and 100W	Provide high power

# CHAPTER 4

## Programmable logic controllers (PLC)

Introduction

Advantages of PLC

Selection and uses of PLC

Architecture basic internal structures

Input/output Processing and Programming

Mnemonics

Master and Jump Controllers

# Introduction

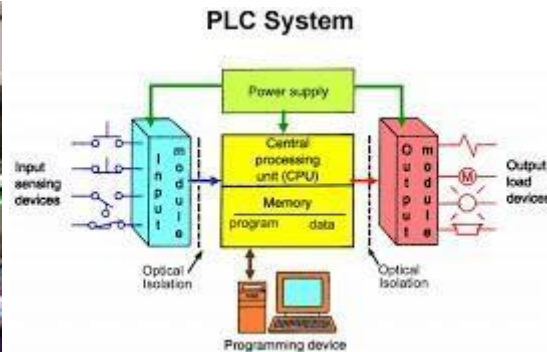

A programmable logic controller (PLC) is a **specialized computer used to control machines and process**. Eliminates much of the hard wiring that was associated with conventional relay control circuits. The program takes the place of much of the external wiring that would be required for control of a process.

PLC stands for Programmable Logic Controllers. They are basically used to control automated systems in industries. They are one of the most advanced and simplest forms of control systems which are now replacing hard-wired logic relays at a large scale.

The programmable logic controller, or PLC, is ubiquitous in process and manufacturing industries today. Initially built to replace electromechanical relay systems, the PLC offers a simpler solution for modifying the operation of a control system. Rather than having to rewire a large bank of relays, a quick download from a PC or programming device enables control logic changes in a matter of minutes or even seconds.



## Advantages of PLC

Before getting into details about PLCs, let's us know 3 reasons why PLCs are being widely used these days

- They are user friendly and easy to operate
- They eliminate the need for hard-wired relay logic
- They are fast
- It is suitable for automation in industries.
- Its input and output modules can be extended depending upon the requirements

## Selection and uses of PLC

PLCs are used in,

- ◆ Transportation System like Conveyor Belt System.
- ◆ Packing and Labeling System in Food & Beverage.
- ◆ Automatic Bottle or Liquid Filling System.
- ◆ Packaging and Labelling System in Pharma Industries.
- ◆ Transportation System like Escalator and Elevator.
- ◆ Industrial Crane Control System for Operation of Overhead Traveling Crane.
- ◆ Glass Industries for glass production and recording data.
- ◆ Paper Industries for the production of Pages, Books or Newspapers, etc.

- ◆ Cement Industries for manufacturing or mixing the right quality and quantities of raw materials, and accuracy of data regarding.
- ◆ Automatic Drainage Water Pump Monitoring and Controlling System.
- ◆ Time and Count-based Control System for an Industrial Machine.

### Architecture basic internal structures

Interior architecture is **the design of a building or shelter from inside out**, or the design of a new interior for a type of home that can be fixed. ... the art and science of designing and erecting buildings and their interiors, along with other related physical features, by a licensed architect.

The information within the PLC is carried by means of digital signals. The internal paths along which digital signals flow are called buses.

What is the basic structure of PLC?

The main components of a PLC consist of a **central processing unit (CPU), power supply, programming device, and input and output (I/O) modules**. The CPU is the brain of the PLC and carries out programmed operations.

What exactly does an interior architect do?

Simply put, an interior architect **designs building interiors & space planning** while an interior designer focuses on the actual furnishing and decoration of an interior. ... Interior architects must take into account the functionality, safety and appearance of the build. The CPU controls and processes all the operations within the PLC. It is supplied with a clock that has a frequency of typically between 1 and 8 MHz. This frequency determines the operating speed of the PLC and provides the timing and synchronization for all elements in the system. The information within the PLC is carried by means of digital signals. The internal paths along which digital signals flow are called buses. In the physical sense, a bus is just a number of conductors along which electrical signals can flow. It might be tracks on a printed circuit board or wires in a ribbon cable.

# Input/output Processing and Programming

How will you process the input and output of PLC?

In a PLC system there will usually be **dedicated modules** for inputs and dedicated modules for outputs. An input module detects the status of input signals such as push-buttons, switches, temperature sensors, etc.. An output module controls devices such as relays, motor starters, lights, etc.

- PLC is continuously running through its program and updating it as a result of the input signals, each such loop is called a cycle.
- Two methods of processing:
  - 1- Continuous updating
  - 2- Mass updating
- continuous updating:
  - The cpu scanning the input channels as they occur in the program instructions. Each input is examined individually (delay time 3 ms). The output is latched so that they retain their status until the next update
- Mass input/ output copying: it works in the following process:
  1. Scan all the inputs and copy into RAM
  2. Fetch and decode and execute all program instruction in sequence, copying output instruction to RAM

- 3- Once the program is executed, the CPU performs diagnostics and communication tasks
- 4- update all outputs

Repeat the sequence. Input/output processing Input/Output

## Input/output unit

1. • The input/output unit provides the interface between the system and the outside world.
2. • The input/ output interface provides isolation and signal conditioning functions so that sensors and actuators can often be directly connected to them without the need for other circuitry.
3. • Out devices: motors, starting coils, solenoid valve, etc
4. • Input devices: temperature sensors, flow sensors, encoders, etc...

# Mnemonics

The **appropriate product category**. A ladder diagram written in alphanumeric characters for easier understanding than the machine language program to be executed by CPU Unit. The mnemonic code can be converted to a ladder diagram in the PLC.

What is a ladder in PLC?

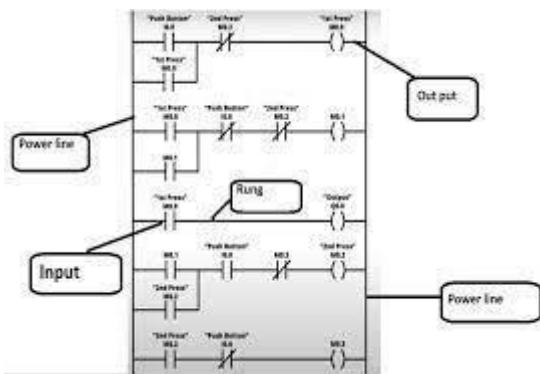

Ladder logic is used to develop software for programmable logic controllers (PLCs) used in industrial control applications. The name is based on the observation that programs in this language resemble ladders, with two vertical rails and a series of horizontal rungs between them.

The **PLC executes the program loaded into it one rung at a time**. As the PLC begins to process the rung, it reads the instructions on the left and determines if the Logic on that side of the rung is set to TRUE. The Logic evaluates to TRUE when a hypothetical current is able to pass through the instructions

## Master and Jump Controllers

### **How to use JUMP Instruction in PLC Ladder Logic?**

**Jump instruction in ladder logic** is used to skip some process or rungs according to the requirement. It is paired with Label which is used to limit the skipping the process.

## What is jump control in PLC?



Jump instruction in ladder logic is **used to skip some process or rungs according to the requirement**. It is paired with Label which is used to limit the skipping the process.

## What does a master control relay do?

In an electrical circuit, Master control relays are **used to shut down a section of an electrical system**. In ladder logic, MCR is used to turn ON one section of a programming line. An MCR option should be opened and closed properly. There is a section of ladder logic implemented between the MCR instruction lines

## How do you use jump instructions?

A jump instruction, like "jmp", just switches the CPU to executing a different piece of code. It's the assembly equivalent of "goto", but unlike goto, jumps are not considered shameful in assembly.



# CHAPTER 5

## Elements of CNC Machines

Introduction to Numerical Control of machines and CAD/CAM

NC machines

CNC machines

5.1.3.CAD/CAM

CAD

CAM

Software and hardware for CAD/CAM

Functioning of CAD/CAM system

Features and characteristics of CAD/CAM system

Application areas for CAD/CAM

# Elements of CNC machines

Introduction

Machine Structure

Guideways/Slide ways

Introduction and Types of Guideways

Factors of design of guideways

Drives

Spindle drives

Feed drive

Spindle and Spindle Bearings

# Introduction to Numerical Control of machines and CAD/CAM

## NC machines

**Numerical control** (also **computer numerical control**, and commonly called **CNC**) is the automated control of machining tools (such as drills, lathes, mills and 3D printers) by means of a computer. A CNC machine processes a piece of material (metal, plastic, wood, ceramic, or composite) to meet specifications by following a coded programmed instruction and without a manual operator directly controlling the machining operation.



## What is NC machine tool?

Numerical Control (NC) refers to the method of controlling the manufacturing operation by means of directly inserted coded numerical instructions into the machine tool.

Numerical control, popularly known as the NC is very commonly used in the machine tools. Numerical control is defined as the form of programmable automation, in which the process is controlled by the number, letters, and symbols. In case of the machine tools this programmable automation is used for the operation of the machines.

The NC technology can be applied to wide variety of operations like drafting, assembly, inspection, sheet metal working, etc. But it is more prominently used for various metal machining processes like turning, drilling, milling, shaping etc. Due to NC all the machining operations can be performed at the fast rate resulting in bulk manufacturing becoming quite cheaper.

# CNC machines

What is a CNC machine do?

A computer numerical controlled (CNC) machine uses a **program to control the operation of machine tools such as lathes and mills**. It takes a raw material (metal, plastic, etc.) and cuts, grinds, drills, turns, mills, and/or shapes it into parts that meet exact specifications.



A CNC machine is a motorized maneuverable tool and often a motorized maneuverable platform, which are both controlled by a computer, according to specific input instructions. Instructions are delivered

to a CNC machine in the form of a sequential program of machine control instructions such as G-code and M-code, then executed. The program can be written by a person or, far more often, generated by graphical computer-aided design (CAD) software and/or computer aided manufacturing (CAM) software. In the case of 3D printers, the part to be printed is "sliced", before the instructions (or the program) is generated. 3D printers also use G-Code.



CNC is a vast improvement over non-computerized machining that must be manually controlled (e.g. using devices such as hand wheels or levers) or mechanically controlled by pre-fabricated pattern guides (cams). In modern CNC systems, the design of a mechanical part and its manufacturing program is highly automated. The part's mechanical dimensions are defined using CAD software and then

translated into manufacturing directives by computer-aided manufacturing (CAM) software. The resulting directives are transformed (by "post processor" software) into the specific commands necessary for a particular machine to produce the component and then are loaded into the CNC machine.



# CAD/CAM

## CAD

CAD or **computer-aided design and drafting (CADD)**, is technology for design and technical documentation, which replaces manual drafting with an automated process. If you are a designer, drafter, architect or engineer, you have probably used 2D or 3D CAD programs such as AutoCAD or AutoCAD LT software

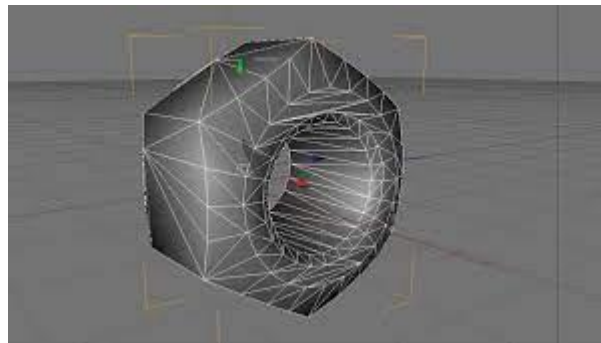
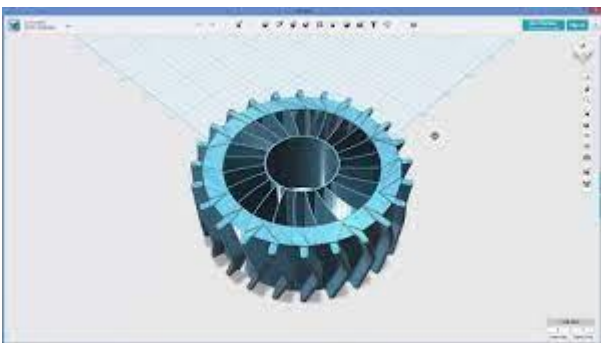

**Computer-aided design (CAD)** is the use of computers (or workstations) to aid in the creation, modification, analysis, or optimization of a design.<sup>[1]</sup> This software is used to increase the productivity of the designer, improve the quality of design, improve communications through documentation, and to create a database for manufacturing.<sup>[2]</sup> Designs made through CAD software are helpful in protecting products and inventions when used in patent applications. CAD output is often in the form of



electronic files for print, machining, or other manufacturing operations.

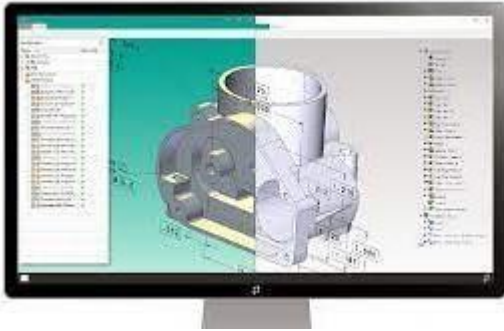

CAD is an important industrial art extensively used in many applications, including automotive, shipbuilding, and aerospace industries, industrial and architectural design, prosthetics, and many more. CAD is also widely used to produce computer animation for special effects in movies, advertising and technical manuals, often called DCC digital content creation. The modern ubiquity and power of computers means that even perfume bottles and shampoo dispensers are designed using techniques unheard of by engineers of the 1960s. Because of its enormous economic importance, CAD has been a major driving force for research in computational geometry, computer graphics (both hardware and software), and discrete differential geometry.

# CAM

A **cam** is a rotating or sliding piece in a mechanical linkage used especially in transforming rotary motion into linear motion.<sup>[1][2]</sup> It is often a part of a rotating wheel (e.g. an eccentric wheel) or shaft (e.g. a cylinder with an irregular shape) that strikes a lever at one or more points on its circular path. The cam can be a simple tooth, as is used to deliver pulses of power to a steam hammer, for example, or an eccentric disc or other shape that produces a smooth reciprocating (back and forth) motion in the *follower*, which is a lever making contact with the cam. A cam timer is similar, and were widely used for electric machine control (an electromechanical timer in a washing machine being a common example) before the advent of inexpensive electronics, microcontrollers, integrated circuits, programmable logic controllers and digital control.

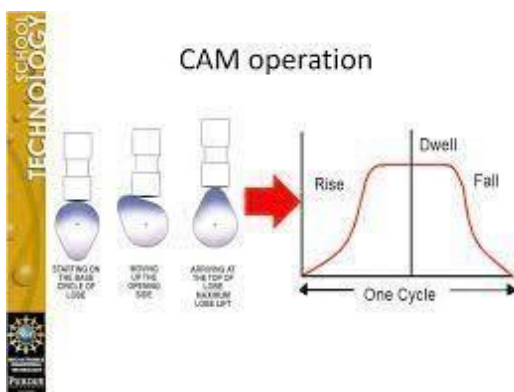

The cam can be seen as a device that converts rotational motion to reciprocating (or sometimes oscillating) motion.<sup>[1]</sup> A common example is the camshaft of an automobile, which takes the rotary motion of the engine and converts it into the reciprocating motion necessary to operate the intake and exhaust valves of the cylinders.



**Computer-aided manufacturing (CAM)** also known as **Computer-aided Modeling** or **Computer-aided Machining**<sup>[1][2][3]</sup> is the use of software to control machine tools and related ones in the manufacturing of work pieces.<sup>[4][5][6][7][8]</sup> This is not the only definition for CAM, but it is the most common;<sup>[4]</sup> CAM may also refer to the use of a computer to assist in all operations of a manufacturing plant, including planning, management, transportation and storage.<sup>[9][10]</sup> Its primary purpose is to create a faster production process and components and

tooling with more precise dimensions and material consistency, which in some cases, uses only the required amount of raw material (thus minimizing waste), while simultaneously reducing energy consumption.<sup>[citation needed]</sup> CAM is now a system used in schools and lower educational purposes. CAM is a subsequent computer-aided process after computer-aided design (CAD) and sometimes computer-aided engineering (CAE), as the model generated in CAD and verified in CAE can be input into CAM software, which then controls the machine tool. CAM is used in many schools alongside Computer-Aided Design (CAD) to create objects.

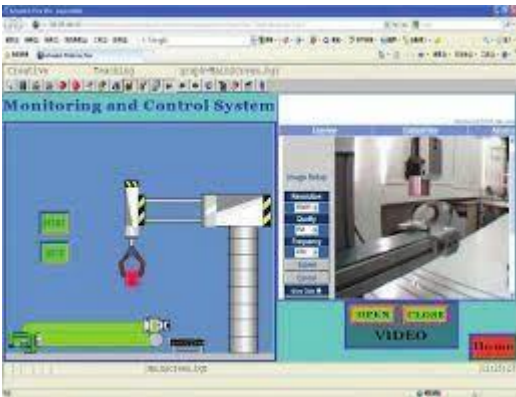

## Software and hardware for

# What software and hardware is used in CAD?

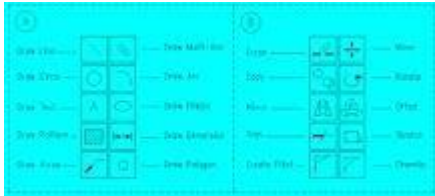

## CADD Hardware

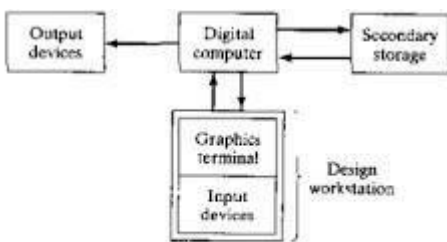
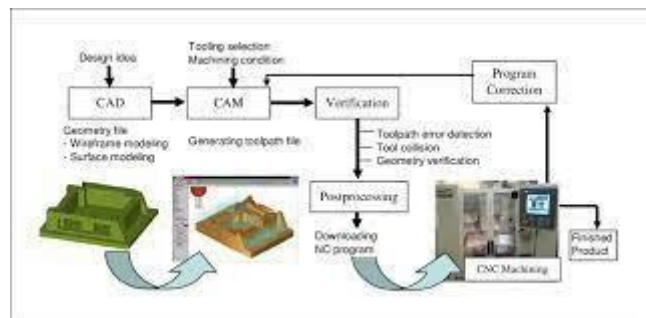

Figure 24.5 Configuration of a typical CAD system.



- System Unit.
- Central Processing Unit (CPU)
- Memory.
- Hard Disk, Floppy Disk, CD-ROM.
- External Storage Devices.
- The Monitor.
- Printers and Plotters.
- Digitizer, PuWhich is best software for CAD CAM?

# Top 6 CAD/CAM tools

- Fusion360.



- SOLIDWORKS 3D CAD.

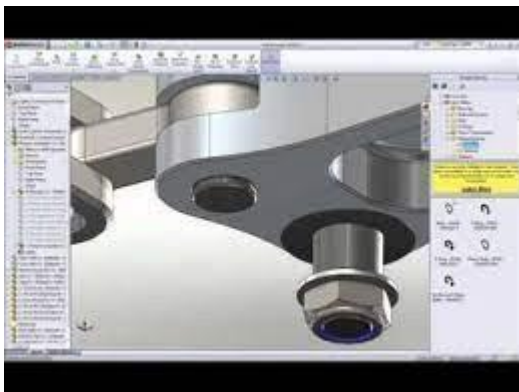

- Solid Edge CAM Pro.

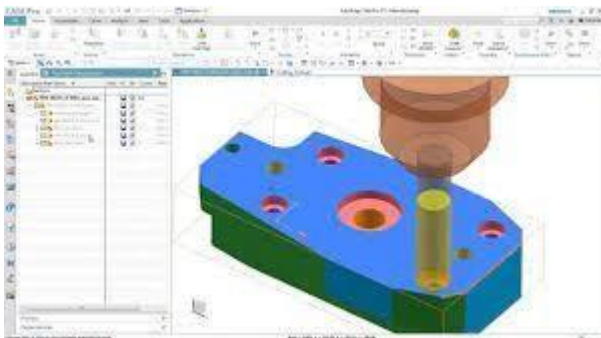

- GibbsCAM.

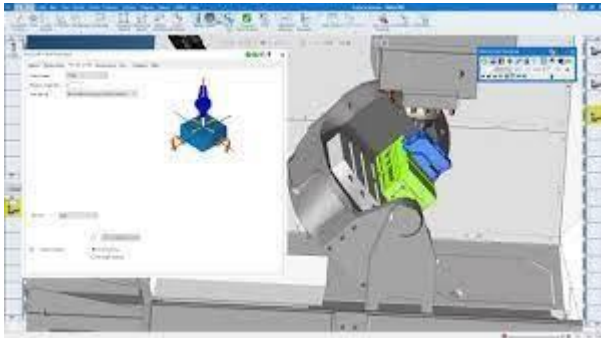

- AutoCAD.



- ck and Mouse.

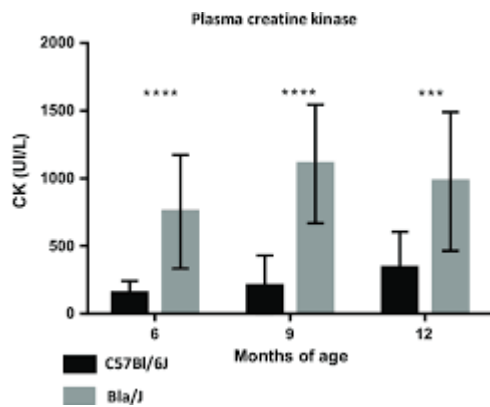

What is CAD CAM hardware?

A CAD/CAM system brings together the user (designers, engineers and draughtsmen), hardware (**computers, visual display and dialogue systems**) and software (programs for calculation, archiving and presentation of graphics)

What are some examples of CAD CAM software?

Examples of CAD/CAM software are **SolidWorks, INVENTOR, CATiA and AutoCAD**. Furthermore, examples of CAM software are SolidCAM and CAMWorks. 3D CAD/CAM software provides the ability to control CNC machinery from 2.5 axis, 3 axis and multi axis CNC machines.



## Functioning of CAD/CAM system

What are the function and benefits of CAM?

The benefits of CAM

**Greater speed in producing components. Greater accuracy and consistency,** with each component or finished product exactly the same. Greater efficiency as computer controlled machines do not need to take breaks. High sophistication in terms of following complex patterns like tracks on circuit boards.

Function of cad

Used by engineers, architects, and construction managers, CAD has replaced manual drafting. It helps users creating designs in either 2D or 3D so that they can visualize the construction. **CAD enables the development, modification, and optimization of the design process.**

## Features and characteristics of CAD/CAM system

### The Feature Technology Feature of CAD/CAM

CAM software should have forward looking features that allow you to work in a traditional programming approach and to step up into a more organized environment that includes storing process knowledge and corporate experiences.

CAM software systems promote many product features, like high-speed machining technologies, multi-axis machining, collision detection and simulation tools. However in recent years there also is another commonly dis-cussed feature called feature technology.

## **Application areas for CAD/CAM**

Main Applications of Computer Aided Design (CAD)

**Solid Modelling** This process is used to create solid components of desired shape by joining and cutting different solid volumes. The final solid model is a virtual replica of an actual product but it can be seen and rotated like a real product. There are two main types: · direct where the model can be edited by undoing or modifying the model directly on the 3D; · parametric where the model is constructed using parameters (variable quantities such as measurements) and the model can be edited at any point in its history.

**Surface Modelling** This process is used to create surfaces of desired shape by trimming, stitching and joining different surfaces to create a final shape model.

**Assembly** This process is used to assemble the models created in solid or surface modelling to create a final assembly. This is used to see the actual fitment of all models and see the actual working of assembly.

**Drafting Detailing** This process is used to create the 2D drawings of components or assemblies; usually directly from a 3D model, although 2D CAD can create 2D drawings directly.

**Reverse Engineering** This process is used to convert the real component into 3D CAD Model. Different types of instruments such as laser scanner, white light scanner,

CMM (coordinate measuring machine) etc. are used to measure or decode the shape of a real model. The virtual model obtained can then be modified in a CAD program

**Main Applications of Computer Aided Manufacture (CAM)**

**Plotter/cutters** Using 2D CAD or graphics software these machines can draw or cut 2D shapes on paper, card or self-adhesive vinyl sheets.

**Laser cutting** Using 2D CAD or graphics software these machines can cut or engrave a wide variety of materials such as card, plywood, acrylic sheet, textiles, glass.

**2.5D Milling** Typically 2.5D machining uses 2D CAD files as the source and cuts in x and y directions (parallel to the machine bed) while lowering the tool progressively through several steps to cut out an object using a rotating tool. Setting tool paths is generally simple and the part cut rapidly.

**3D Milling** 3d machining typically used STL files from 3D CAD programs as a source and requires all three axes of the mill to be able to move simultaneously. 3D machining can take a very long time even on fast, modern machines and especially if a high quality finish is required. A fourth or rotary axis can also be added to create turned parts.

Turning CAM software automates traditional turning on a lathe including roughing, grooving, threading and finishing for faster, more accurate results. 3D printing 3D printing is a process of making a three-dimensional object of virtually any shape from a digital model. It is achieved using an additive process where successive layers of material (usually thermoplastic) are laid down. Each layer is a thinly sliced, horizontal cross-section of the eventual object. Each object begins with a CAD file, created with a 3D modelling programme, or by reverse engineering.

# Elements of CNC machines

## Introduction

The development of Computer Numerically Controlled (CNC) machines is a tremendous contribution to the manufacturing industry. Simply put, a CNC system receives and interprets the data and then controls certain actions accordingly. The CNC systems, a versatile form of soft automation, are mostly used in the lathe machine, milling machine, laser machine, sheet metal process, etc. The concept was originally developed to control operation and motion of machine tools.

The CNC is a computer-based electronic equipment, as mentioned earlier, which receives information in digital form from input devices, as well as positional information of certain elements of the machine. Then it interprets the digital data as requirements for new positions of the machine elements and gives appropriate commands of direction.

## Machine Structure

The mechanism of a mechanical system is assembled from components called machine elements. These elements provide structure for the system and control its movement. The structural components are, generally, the frame members, bearings, splines, springs, seals, fasteners and covers.

# What is structure in theory of machine?

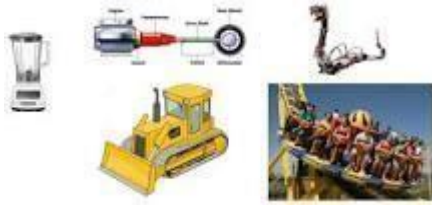

A structure is **an assembly of resistant bodies (known as members) such that these bodies don't have any relative motion between them.** A structure is meant for carrying loads. For example, a building, a roof truss, a railway bridge, machine frames, etc. The degree of freedom of a structure is zero.

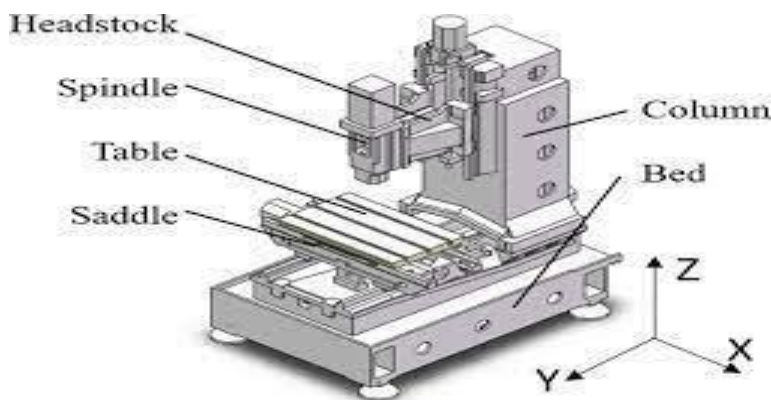



# Guideways/Slide ways

## Introduction and Types of Guideways

What are guideways and slideways?

**The friction between the sliding surfaces** is called as guideways with sliding friction. These guideways are also called as slideways. The slideways are further classified according to the lubrication at the interface of contacting surfaces. The friction between the sliding surfaces may be dry, semi-liquid, and liquid.

# Guideway

The Guideway is one of the important elements of machine tool. The main function of the guideway is to make sure that the cutting tool or machine tool operative element moves along predetermined path. The machine tool operative element carries workpiece along with it. The motion is generally circular for boring mills, vertical lathe, etc. while it is straight line for lathe, drilling, boring machines, etc.

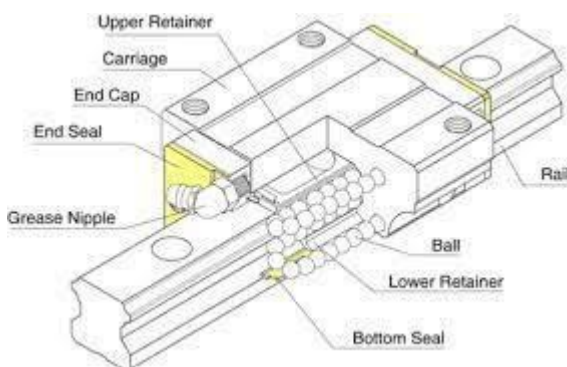

The guideways are mainly classified according to the nature of friction between contacting surfaces of the operative element :

- (a) Guideways with sliding friction
- (b) Guideways with rolling friction

## (a) Guideways with Sliding Friction

The friction between the sliding surfaces is called as guideways with sliding friction. These guideways are also called as slideways. The slideways are further classified according to the lubrication at the interface of contacting surfaces. The friction between the sliding surfaces may be dry, semi-liquid, and liquid. When the lubrication is absent in between contacting surfaces, it is called as dry friction. Dry friction is rarely occurred in machine tools.

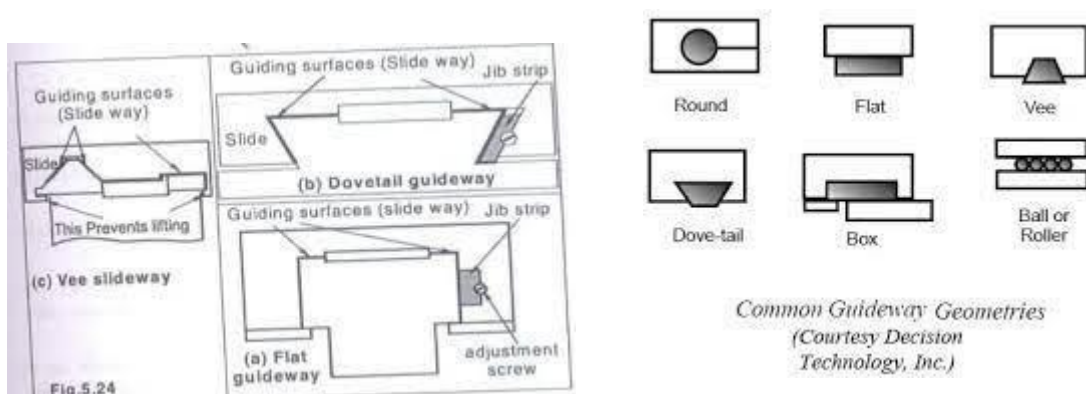

These are also called as anti friction ways. The anti friction slideways may be classified according to the shape of the rolling element as :

- (a) Roller type anti friction ways using cylindrical rollers.
- (b) Ball type anti friction ways using spherical balls.

## Slide ways

A slideway is **used to control the direction or line of action of the translational movement of the table or carriage on which the tools or work are held.** Although VEE type has certain advantages, it is the FLAT & DOVETAIL slideway forms which have commonly been used on CNC machine tools.

What is the function of slideway?

Slideways or ways are used as **the medium on which to slide heavy equipment.** This type of system is used when the equipment to be transported is either very heavy or when the movement requires high precision.

## Drives

Mechatronic systems comprise a **large variety of electrical drives.** ... The most important equations of these electromagnetic components will be stated in such a form that they can be used to describe the static and dynamic behavior of mechatronic overall systems.

# What is a Mechanical Drive?

Mechanical drives are **a series of components that manages the transmission**. This power can be channeled to power other equipment like pumps, blowers, air compressors, and other common industrial machinery.

Mechatronic systems comprise a large variety of electrical drives. Their main purpose is to generate translational or rotational forces or to change the position of mechanical components. Electrical power-generating machines, which are used to drive power-consuming machines, and electrical actuators (control motors, servo drives), which are employed to drive control valves, are typical examples. In both cases, a distinction can be made between rotational and translational forces and motions. In the following sections, the construction and modeling of electromagnets, DC and AC motors will be outlined. The most important equations of these electromagnetic components will be stated in such a form that they can be used to describe the static and dynamic behavior of mechatronic overall systems.

# Spindle drives

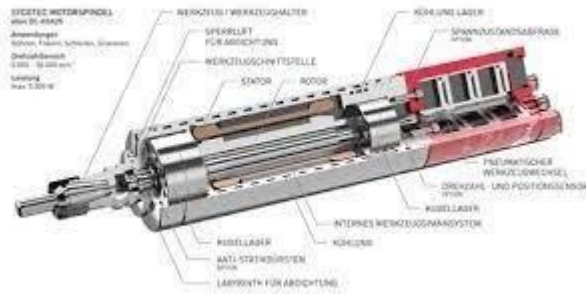

A **spindle drive** is a primitive type of transmission. A rod, referred to as a spindle, is attached to the output end of an engine. This rod then comes in direct contact with a tire.

There are several limitations to this design. The spindle-tire interface is prone to inefficiency and slippage since the contact area is very limited. Water of any sort on the tire will render a spindle drive unusable until it dries.

# Advantages

- **Simplicity.** The greatest advantage to a **spindle driven** transmission is simplicity. It is because of this simplicity that **spindle driven** scooters are the generally the least expensive scooters available.
- **Low maintenance. Spindle drives** also require no lubrication and minimal maintenance.

# Disadvantages

**Wear.** Spindles cause excessive wear on the tire to which they are connected and require constant re-adjustment in order to maintain an optimal pressure on a tire's surface. the black magic spindle is an aftermarket spindle that has TONS of grip, but it also wears your tire down alot faster than a stock or knurled ADA spindle.

# Feed drive

## Feed drive

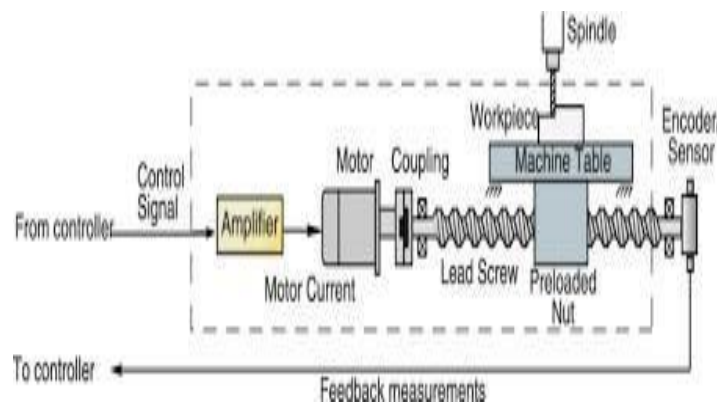
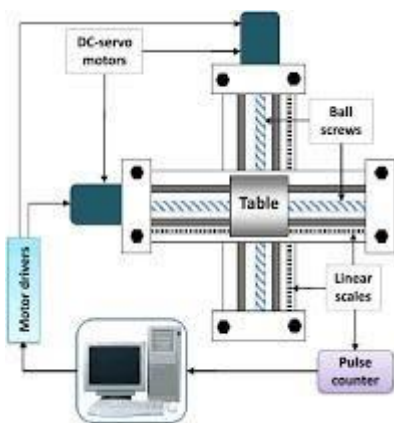

The feed drive is one of the most important parts of every CNC machine tool. ... The feed drive main purpose is to **move the working parts of machine tool** (working table, tool unit, spindle unit etc.) through machine axes. A separate feed drive is necessary for every machine axis.



What are the components of feed drive?

The feed drive consists of **an electromotor and mechanical transmission elements**. The mechanical transmission elements comprise all the machine parts which lie in the torque (power) transmission flow between the servo motor and the tool or workpiece.

What are the components of feed drive?

The feed drive consists of **an electromotor and mechanical transmission elements**. The mechanical transmission elements comprise all the machine parts which lie in the torque (power) transmission flow between the servo motor and the tool or workpiece.

What is feed drive system?

**FEED DRIVES.** A feed drive consists of **a feed servomotor and an electronic controller.** Unlike a spindle motor, the feed motor has certain special characteristics, like constant torque and positioning.

## Spindle and Spindle Bearings

Machine tools are generally equipped with spindles for locating the job (to provide centering), holding tool or work, rotating the work or the tool and feeding the tool also as in the case of drilling machine. The spindles are made out of hollow steel shaft with a tapered hole at the front end for receiving the centering element (spindle nose).

It is desirable that the axis of the tapered hole and the axis of the spindle rotation be concentric. Machining accuracy depends to a considerable extent upon the rotational

accuracy of the spindle which transmits motion to the cutting tool or to the work. Generally machine tool spindles are made up of allow low carbon steel heat treated to give a case hardened surface.

Such a spindle possesses resistance to wear combined with a tough core for strength in torsion. High precision spindles for external grinding machines are made from Nitralloy. Spindles of heavy machine tools are made.

# CHAPTER 6

## Robotics



6.1 Definition, Function and laws of robotics

6.2 Types of industrial robots

    Robotic systems

    Advantages and Disadvantages of robots

# Definition, and laws of robotics

## Definition



Robotics is an interdisciplinary sector of science and engineering dedicated to the design, construction and use of mechanical robots. Our guide will give you a concrete grasp of robotics, including different types of robots and how they're being applied across industries.

Robotics is the intersection of science, engineering and technology that produces machines, called robots, that

substitute for (or replicate) human actions. Pop culture has always been fascinated with robots. R2-D2. Optimus Prime. WALL-E. These over-exaggerated, humanoid concepts of robots usually seem like a caricature of the real thing...or are they more forward thinking than we realize? Robots are gaining intellectual and mechanical capabilities that don't put the possibility of a R2-D2-like machine out of reach in the future.

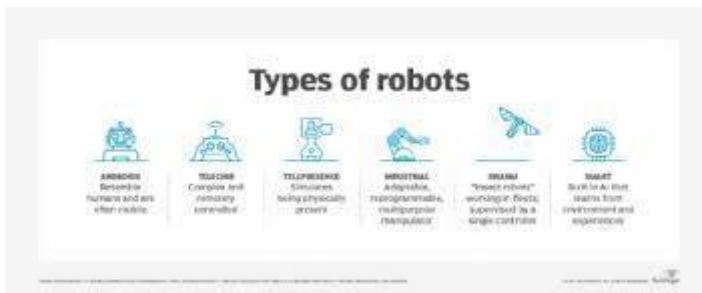

# Function

## ***Robot Function***

- Generate specific motion of joints
- Integrate tooling and sensors

## ***Robot Processes***

- Path following
- Repetitive configuration moves
- Telerobotics
- Target moves versus taught moves

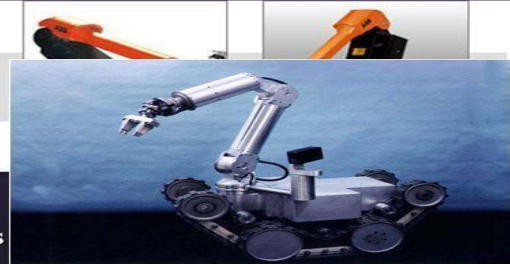

ME 486 - Automation

## Function of Robots



### Independent

- No direct human control
- Replaces human activity



### Dependent

- Interfaces directly with humans
- Supplements human activity



# Laws of robotics

The **Three Laws of Robotics** (often shortened to **The Three Laws** or known as **Asimov's Laws**) are a set of rules devised by science fiction author Isaac Asimov. The rules were introduced in his 1942 short story "Runaround" (included in the 1950 collection *I, Robot*), although they had been foreshadowed in some earlier stories. The Three Laws, quoted from the "Handbook of Robotics, 56th Edition, 2058 A.D.", are:

## Three Laws of Robotics

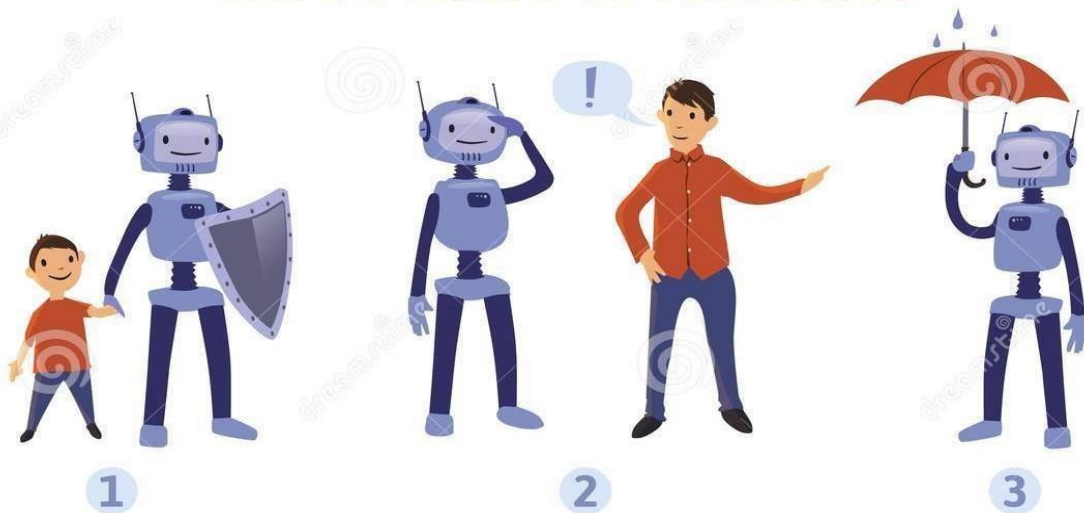

1

A robot may not injure a human being or, through inaction, allow a human being to come to harm.

2

A robot must obey the orders given it by human beings except where such orders would conflict with the First Law.

3

A robot must protect its own existence as long as such protection does not conflict with the First or Second Laws.



Download from  
**Dreamstime.com**

This watermarked comp image is for previewing purposes only.



ID 110683868

© Tatyana Merkusheva | Dreamstime.com



## **First Law**

A robot may not injure a human being or, through inaction, allow a human being to come to harm.

## **Second Law**

A robot must obey the orders given it by human beings except where such orders would conflict with the First Law.

## **Third Law**

A robot must protect its own existence as long as such protection does not conflict with the First or Second Law.

# Zeroth Law

A robot may not harm humanity, or, by inaction, allow humanity to come to harm.

The Three Laws, and the zeroth, have pervaded science fiction and are referred to in many books, films, and other media. They have impacted thought on ethics of artificial intelligence as well.

## Zeroth law of Thermodynamics

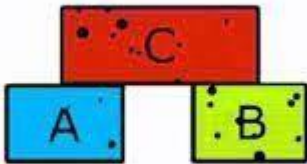

Zeroth law of thermodynamics statement:

*"If two bodies A and B are in thermal equilibrium with third body C, then body A and B are also in thermal equilibrium with each other."*

For example, in the above simulation, you can see that body A and body B are

# Types of industrial robots

## Cartesian Robots



Cartesian robots, which are also called linear robots or gantry robots, are industrial robots that work on three linear axes that use the Cartesian Coordinate system (X, Y, and Z), meaning they move in straight lines on 3-axis (up and down, in and out, and side to side). Cartesian robots are a popular choice due to being highly flexible in their configurations, giving users the ability to adjust the robot's speed, precision, stroke length, and size. Cartesian Robots are one of the most commonly used robot types for industrial applications and are often used for CNC machines and 3D printing.

## SCARA Robots



SCARA is an acronym that stands for Selective Compliance Assembly Robot Arm or Selective Compliance Articulated Robot Arm. SCARA Robots function on 3-axis (X, Y, and Z), and have a rotary motion as well. SCARA Robots excel in lateral movements and are commonly faster moving and have easier integration than Cartesian Robots. Typically, SCARA robots are used for assembly and palletizing, as well as bio-med application.

# Articulated Robots



Articulated Robots mechanical movement and configuration closely resembles a human arm. The arm is mounted to a base with a twisting joint. The arm itself can feature anywhere from two rotary joints up to ten rotary joints which act as axes, with each additional joint or axis allowing for a greater degree of motion. Most Articulated Robots utilize four or six-axis. Typical applications for Articulated Robots are assembly, arc welding, material handling, machine tending, and packaging.

# Cylindrical Robots

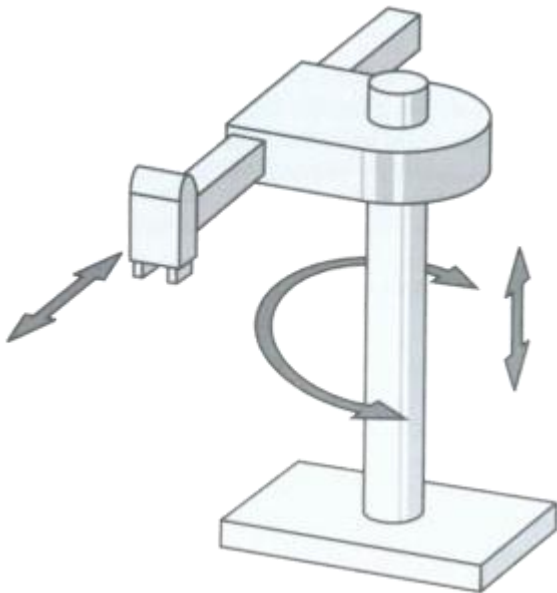

Cylindrical Robots have a rotary joint at the base and a prismatic joint to connect the links. The robots have a cylindrical-shaped work envelop, which is achieved with rotating shaft and an extendable arm that moves in a vertical and sliding motion. Cylindrical Robots are often used in tight workspaces for simple assembly, machine tending, or coating applications due to their compact design.

# Delta Robots



Delta Robots, or parallel robots, possess three arms connected to a single base, which is mounted above the workspace. Delta Robots work in a dome-shape and can move both delicately and precisely at high speeds due to each joint of the end effector being directly controlled by all three arms. Delta Robots are often used for fast pick and place applications in the food, pharmaceutical, and electronic industries.

## Polar Robots

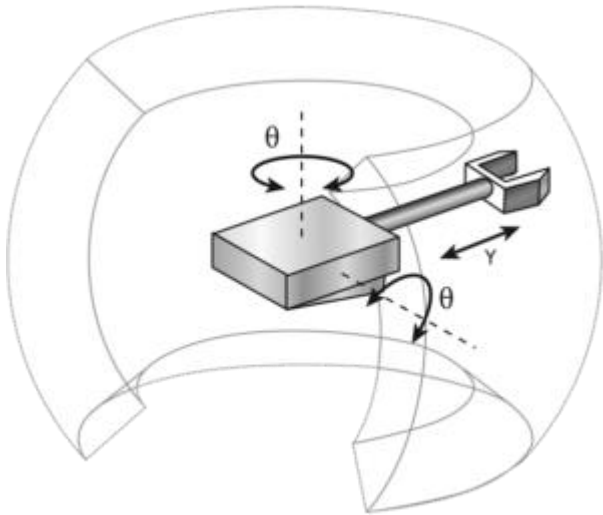

Polar Robots, or spherical robots, have an arm with two rotary joints and one linear joint connected to a base with a twisting joint. The axes of the robot work together to form a polar coordinate, which allows the robot to have a spherical work envelope. Polar Robots are credited as one of the first types of industrial robots to ever be developed. Polar robots are commonly used for die casting, injection molding, welding, and material handling.



# Collaborative Robots



Collaborative Robots or Cobots are robots that can directly and safely interact with humans in a shared workspace. There are numerous types and brands of collaborative robots on the market – learn more here. Cobots are typically used for pick and place, palletizing, quality inspection, and machine tending.

# Robotic systems

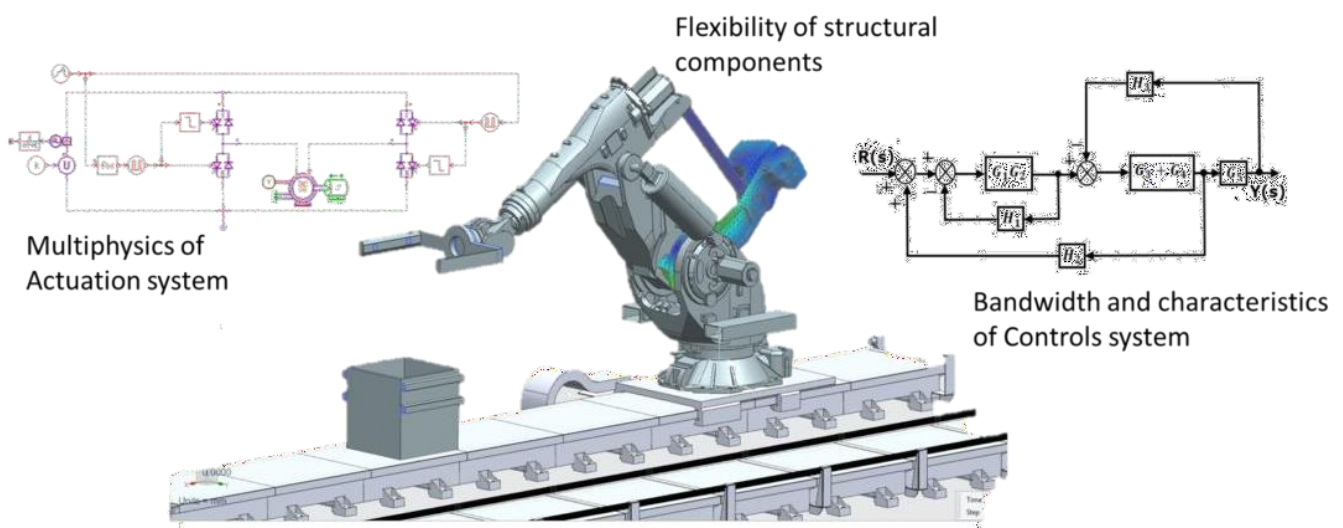

What are the 5 main parts of a robotic system?

The design of industrial robots makes them capable of performing human-like functions. This design consists of five main components which are **the controller, sensors, robot arm, end effector, and drive.**

## How do robotic systems work?



A typical robot has a movable physical structure, a motor of some sort, a sensor system, a power supply and a computer "brain" that controls all of these elements. Essentially, robots are man-made versions of animal life -- they are machines that **replicate human and animal behavior**.

There are three types of robotic systems –

- ★ The manipulation robotic system,
- ★ The mobile robotic system
- ★ The data acquisition and control robotic system.

The manipulation robot system is the most commonly used in the manufacturing industry. These systems are made up of many of the robot arms with 4-6 axes and varying degrees of freedom. They can perform several different

functions, including welding, material handling and material removal applications.

- The mobile robotic system is a bit different. This system consists of an automated platform that moves items from one place to another. While these robot systems are used heavily in manufacturing for carrying tools and spare parts, they are also used in the agricultural industry for transporting products. These can also be used by several different industries because of their ability to swim and fly, as well as move along the ground.
- Data acquisition and control robotic systems are used to gather, process and transmit data for a variety of signals. They are also used in software for engineering and business. Many of the mobile robotic systems can use signals from these systems.

# Advantages and Disadvantages of robots

## What are the advantages?

- In many situations robots can increase productivity, efficiency, quality and consistency of products:
  - Unlike humans, robots don't get bored
  - Until they wear out, they can do the same thing again and again
  - They can be very accurate – to fractions of an inch (as is needed for example in manufacturing of microelectronics)
- Robots can work in environments which are unsafe for humans – in the nuclear or chemical industries for example
- Robots don't have the same environmental requirements that humans do – such as lighting, air conditioning or noise protection
- Robots have some sensors/actuators which are more capable than humans

## What are the disadvantages?

- The use of robots can create economic problems if they replace human jobs
- Robots can only do what they are told to do – they can't improvise
  - This means that safety procedures are needed to protect humans and other robots
- Although robots can be superior to humans in some ways, they are less dexterous than humans, they don't have such powerful brains, and cannot compete with a human's ability to understand what they can see.
- Often robots are very costly – in terms of the initial cost, maintenance, the need for extra components and the need to be programmed to do the task

**THANK YOU!!!!**